

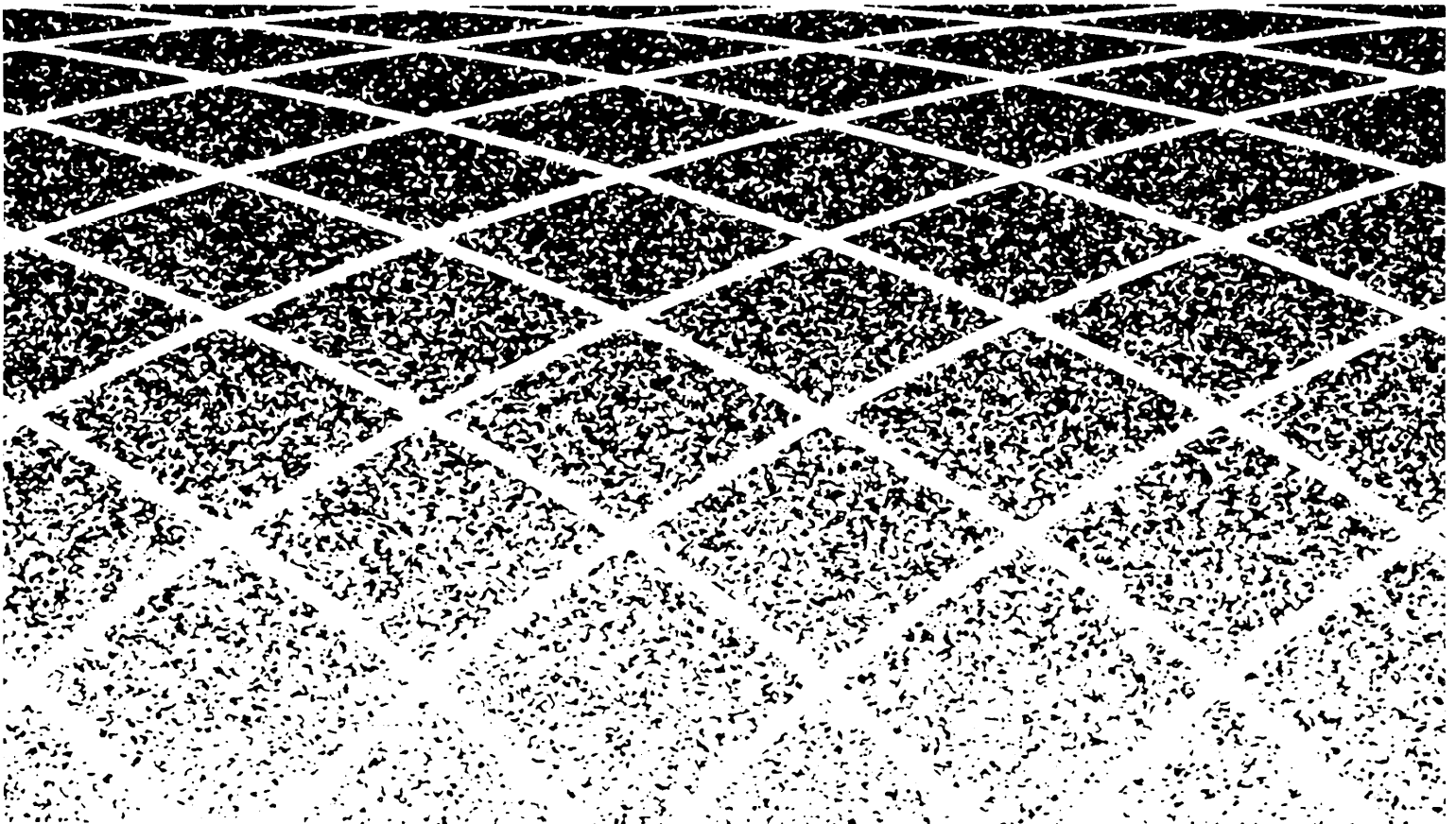

PARTNER<sup>®</sup> PagePac<sup>®</sup>  
Installation and Use



## **NOTICE**

Every effort was made to ensure that the information in this manual was complete and accurate at the time of printing. However, information is subject to change.

## **Federal Communications Commission (FCC) Information**

For important FCC interference, registration, and repair information, see Appendix C of this book.

## **Trademarks**

PARTNER is a registered trademark of AT&T.

PagePac and PageGuard are registered trademarks of HARRIS CORPORATION Dracon Division.

## **Warranty**

AT&T provides a limited warranty to this product. Refer to "AT&T Limited Warranties and Limitation of Liability" in Appendix C.

## **Ordering Information**

The order number for this book is 518-455-016. To order copies of this book, call 1 800 432-6600 in the U.S. or 1 800 255-1242 in Canada. For more information on how to order this and other system reference materials, refer to "Reference Materials" in the section entitled "About This Guide." For information on ordering replacement parts, accessories, and other compatible equipment, refer to "Ordering Information" in the section entitled "Auxiliary Equipment", page 1-4.

## **Support Telephone Numbers**

In the U.S., AT&T provides a toll-free customer helpline 24 hours a day. Call the AT&T NTSC group at 1 800 552-3293 or the AT&T Helpline at 1800628-2888 if you need assistance when installing, programming, or using your system.

For assistance in Canada, contact your local AT&T authorized dealer.

---

# Contents

---

<b>About This Guide</b>	<b>v</b>
-------------------------	----------

---

<b>1. Overview</b>	<b>1-1</b>
■ Features and Capabilities	1-2
■ Module Components	1-3
■ Auxiliary Equipment	1-4
■ Specifications	1-5

---

<b>2. Installation</b>	<b>2-1</b>
■ Important Safety Instructions	2-2
■ Before You Start	2-3
■ PARTNER PagePac Module Installation	2-4
■ Selecting the Interface Mode	2-11

---

<b>3. Page/Speaker Mode Installation</b>	<b>3-1</b>
■ PARTNER PagePac Paging Access	3-2

---

<b>4. Doorspeaker Mode Installation</b>	<b>4-1</b>
■ AT&T Doorspeaker	4-2

---

**5. Accessory Features 5-1**

- Installing a Music Source 5-2
- Volume Adjustment (Page/Music) 5-3
- Using a Microphone with the PARTNER PagePac System 5-4
- Night Bell Service 5-5

---

**6. Programming 6-1**

- Overview 6-2
- Programming Options 6-2
- Programming Procedures 6-5
- Night Bell 6-9
- Ring Down 6-10

---

**7. Operating Procedures 7-1**

- Overview 7-2
- Primary Paging Zones 7-2
- Auxiliary Paging Zone 7-6
- Input Priorities 7-7

---

**A. Troubleshooting A-1**

---

**B. Secondary Circuit Protection B-1**

---

**C. FCC and Warranty Information C-1**

---

**IN Index IN-i**

# About This Guide

---

This manual provides all the necessary information for installing the PARTNER® PagePac® paging system with a PARTNER® Plus or PARTNER® II AT&T phone system. In addition, complete information covering product features and capabilities, as well as operation and test instructions, will be covered.

## How to Use This Guide

---

If you are not familiar with the operation of your PARTNER Plus or PARTNER II AT&T phone system, take some time to review the accompanying user/installation manuals for those systems. This will provide a better foundation for installation of the PARTNER PagePac module with your AT&T phone system.

This manual should be read in its entirety before attempting to install the PARTNER PagePac module.

**Section 1** provides an overview of the PARTNER PagePac module FEATURES AND CAPABILITIES, along with a description of what has been included with your PARTNER PagePac module.

**Section 2** covers INSTALLATION. This section provides necessary information for installing the PARTNER PagePac module with your PARTNER Plus or PARTNER II AT&T phone system and connecting customer provided auxiliary equipment to the PARTNER PagePac module.

**Section 3** continues with installation steps and wiring examples for PAGE/SPEAKER MODE. This section contains Zone 1 and 2 remote amplifier configurations, Zone 3 auxiliary paging features, and a *quick-test* to ensure that your installation is operational at this point.

**Section 4** provides DOORSPEAKER MODE information and installation steps specifically for adding doorspeaker equipment to zones 1 and 2. Configuration information, wiring examples, and a *quick-test* are also covered.

**Section 5** contains ACCESSORY FEATURES information for installing a music source, a high fidelity microphone, adjusting music/page volume from a touch-tone phone, and connections for Night Bell service.

**Section 6** has the necessary programming information; refer to this section once the PARTNER PagePac module (and auxiliary equipment) have been installed and tested.

**Section 7** contains OPERATING PROCEDURES information for each of the PARTNER PagePac features and provides useful examples.

**Appendixes** cover TROUBLESHOOTING, SECONDARY CIRCUIT PROTECTION, and FCC and WARRANTY INFORMATION.

Use the Contents and Index to locate specific items of interest.

# Product Safety Labels

---

This book contains several safety labels, identified by a 

## CAUTION:

Indicates the presence of a hazard that **will** or **can** cause *minor personal injury or property damage if the hazard is not avoided.*

## WARNING:

Indicates the presence of a hazard that **can** cause *severe or fatal personal injury if the hazard is not avoided.*

Carefully read all WARNING labels. Opening the PARTNER PagePac module or phone system backplane will expose you to hazardous voltages, which can cause severe personal injury or death. Also read "Safety Instructions" on page 2-2 before performing any installation procedures.

## Reference Materials

---

If you do not have the PARTNER Plus or PARTNER II "Communications System Installation and Use" guide, please order the appropriate manual from AT&T. This guide contains important information pertaining to the installation, programming, and operation of the PARTNER Plus phone system.

To order additional reference materials, call the AT&T Customer Information Center:

In the U.S.: 1-800-432-6600

In Canada: 1-800-255-1242

## How to Comment on This Guide

---

A feedback form is located at the end of this guide, after the appendixes. If the feedback form is missing, send your comments and recommendations for changes to: A. Sherwood, AT&T, Room 2A-25, 99 Jefferson Road, Parsippany, NJ 07054 (Fax: 201 887-6898).

# 1

---

# Features and Capabilities

---

*Programming is accomplished through your PARTNER system phone or a standard touch-tone phone.*

*This port is also used to program the PARTNER PagePac paging system.*

*\*If you use equipment that rebroadcasts music or other copyrighted materials, you may be required to obtain a license from a third party such as ASCAP or BMI.*

The PARTNER PagePac paging system can be installed with an AT&T PARTNER Pius or PARTNER II communications system. Listed below is an overview of the basic features of the PARTNER PagePac paging system along with some of the additional capabilities this module provides:

- **Primary Paging Zones (Zones 1 and 2)** —Provides two independently fully-programmable zones, each of which can be configured for speaker output, door control, or an auxiliary amplifier. In addition, adjustment of the two primary zones' speaker volumes can be accomplished simply from any PARTNER system phone or any standard touch-tone phone on the PARTNER system.
- **Auxiliary Amplifier Zone (Zone 3)** —provides a third, 0 dBm (600 ohms termination) output zone and a control closure suitable for connection to a remote amplifier.
- **Telephone Access** —Connects to a PARTNER station port, a PARTNER CO port (see trunk adapter below), or PARTNER Page port. Permits a user to page by dialing the telephone access port from a PARTNER system phone or a standard touch-tone phone.
- **Remote Volume Adjustment** —Permits the customer/installer to adjust the volume of each primary zone by means of the keys on any touch-tone telephone on the PARTNER system. This feature is especially useful for speakers which are hard to reach, such as high-ceiling locations (zones 1 and 2).
- **Microphone Attendant Access** —Provides an interface input for microphone access pages.
- **Night Bell** —Connects to a PARTNER (station) port that has been configured for night service. Generates tones over the paging system when an incoming call is detected.
- **Music Input\*** —Connects to a music source. Music will be routed to all specified zones when paging is not active.
- **Paging Amplifier** —Provides a maximum of 4 watts of power for each of the two primary paging zones. Supports voice coil (3.4 Vrms) speakers only (zones 1 and 2).
- **Talkback** —Allows specified paging speakers to be used as an intercom (zones 1 and 2).
- **Door Control** —Connects a paging zone up to two Doorspeakers. Provides both Door Bell and Door Ajar inputs and a Door open output (zones 1 and 2).
- **Trunk Adapter** —Permits the user to conserve PARTNER station ports by connecting the paging system to a PARTNER CO port through an external Trunk Adapter.
- **Zone Overload Warning** —Detects when one of the primary paging zones is drawing too much power and automatically turns on a warning light and temporarily suspends-output to the zone.



# Module Components

The PARTNER PagePac unit can be mounted directly to a wall or on a desk next to your current PARTNER Plus or PARTNER II phone system installation (see Section 2, Installation for complete information). The information key in Figure 1-1 below illustrates the location and description of the PARTNER PagePac features.

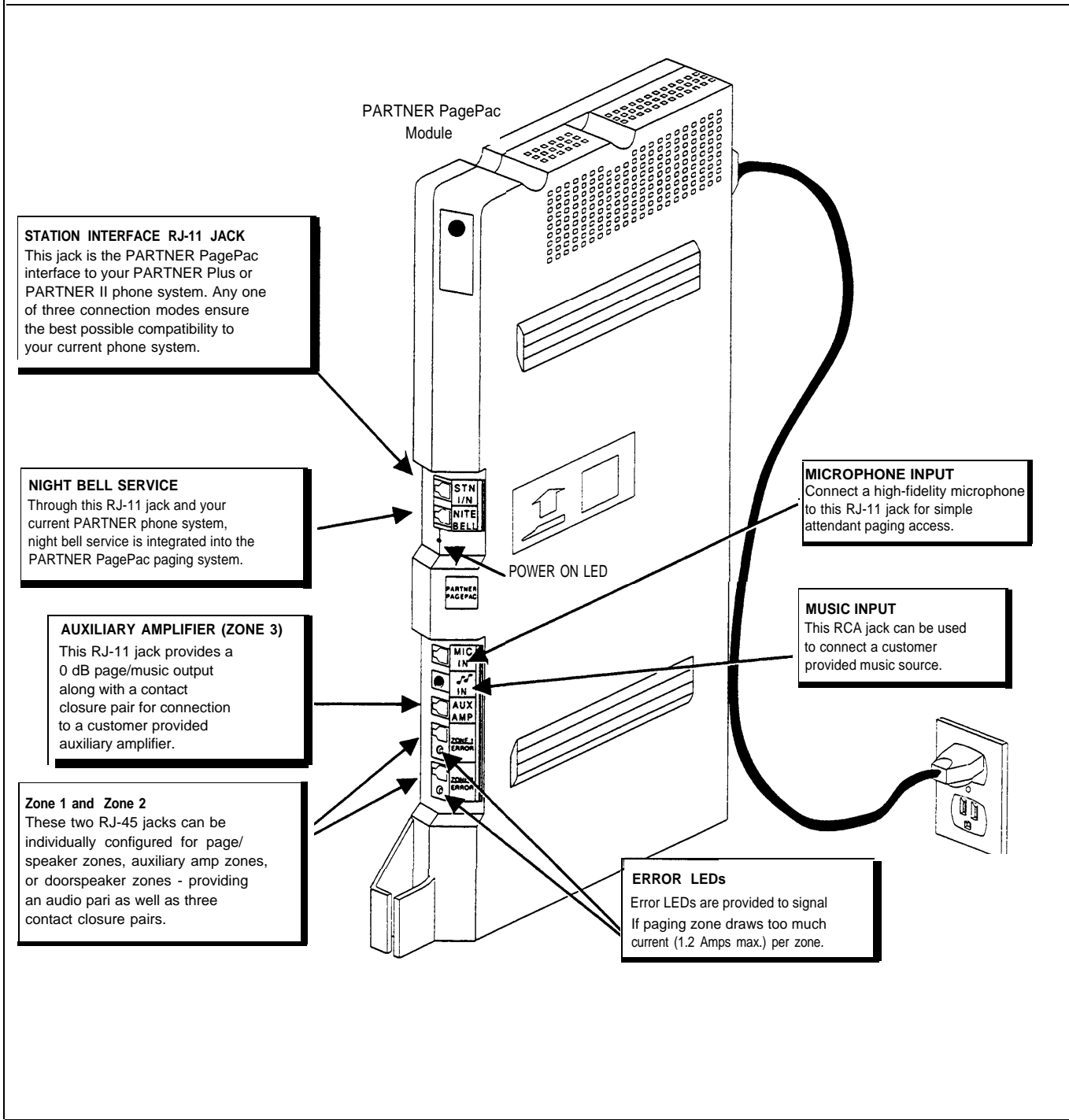

Figure 1-1. PARTNER PagePac Paging System Features (Inputs / Outputs)

# Auxiliary Equipment

---

## Ordering Information

---

The PARTNER PagePac paging system provides full-paging capability to your small or large business. In addition, this module provides an interface for an AT&T Doorspeaker. Listed below are the various speakers, amplifiers, and doorspeaker products recommended for use with the PARTNER PagePac.

**IMPORTANT: Voice Coil (3.4V) speakers only for direct connections to zones 1 and 2.**

*NOTE: The PagePac 6 Plus is NOT supported.*

**IMPORTANT: The PARTNER Plus Doorphone PEC 5324-003 is NOT compatible with the PARTNER PagePac paging system.**

- **Speakers** —a full range of speaker products is available for use with the PARTNER PagePac module—from wall or ceiling mount speakers to horn-type speakers. Refer to Table 3-1 (page 3-4) for the speaker best suited for your application.
- **Amplifiers** —Depending on your paging applications, several amplifiers (auxiliary) are available. These include the PagePac 6 (PEC 5323-006), a 6-watt small amplifier, PagePac 20 (PEC 5323-005), a 20-watt small amplifier, or the PagePac Plus D20, D100, or D300 series AmpliCenters (PECs 5328-020, 5328-100, 5328-300) designed for larger area paging demands.
- **Microphone** —The AT&T Microphone (PEC 5335-400) is compatible with the PARTNER PagePac module. This microphone provides excellent audio fidelity and has an On/Off contact closure.
- **Doorspeaker** —The AT&T Doorspeaker (PEC 5330-120) is compatible with the PARTNER PagePac module. This indoor/outdoor speaker can be surface or flush-mounted to a wall and provides a push-button for alerting inside personnel that the door needs attention.



2

---

# Important Safety Instructions

---

Always follow these basic safety precautions when using the PARTNER PagePac paging system and PARTNER Plus or PARTNER II phone system.

1. Read and understand all instructions.
2. Follow all warnings and instructions marked on the product.
3. DO NOT block or cover ventilation slots and openings. They prevent the product from overheating. DO NOT place the product in an enclosure that does not have sufficient ventilation.
4. Never spill liquid on the product or drop objects into the ventilation slots and openings. Doing so may result in serious damage to the components.
5. Repair or service must be performed by a qualified repair person.
6. The product is provided with a three-wire grounded type plug. This is a safety feature. Do not defeat the safety purpose of the grounding type plug. DO NOT staple or otherwise attach the AC power supply cord to the building or surface.
7. DO NOT use the product near water or in a wet or damp place (such as a wet basement).

## Additional Safety Instructions for Installation Personnel

---

Install the product to meet all the environmental and electrical requirements listed in the specifications (see page 1-5).

1. DO NOT install telephone wiring during a lightning storm.
2. DO NOT install telephone jacks in a wet location unless the jack is specially designed for wet locations.
3. Never touch uninsulated telephone wires or terminals, unless the telephone line has been disconnected at the network interface.
4. Use caution when installing or modifying telephone lines.
5. The PARTNER PagePac unit must be securely wall mounted.

### CAUTION:

*If any wiring from the extension jacks leave the building premises, you must install AT&T 503A1 IROB protectors (see Appendix B).*

# Before You Start

Before installing your PARTNER PagePac paging system, read and understand the safety instructions on page 2-2. In addition, be sure to have the necessary parts. Provided below in Figure 2-1 are the contents of the shipping carton. In addition, you will need a screwdriver if you mount the paging system to a wall. For testing purposes, you will need a PARTNER system phone or a standard touch-tone phone.

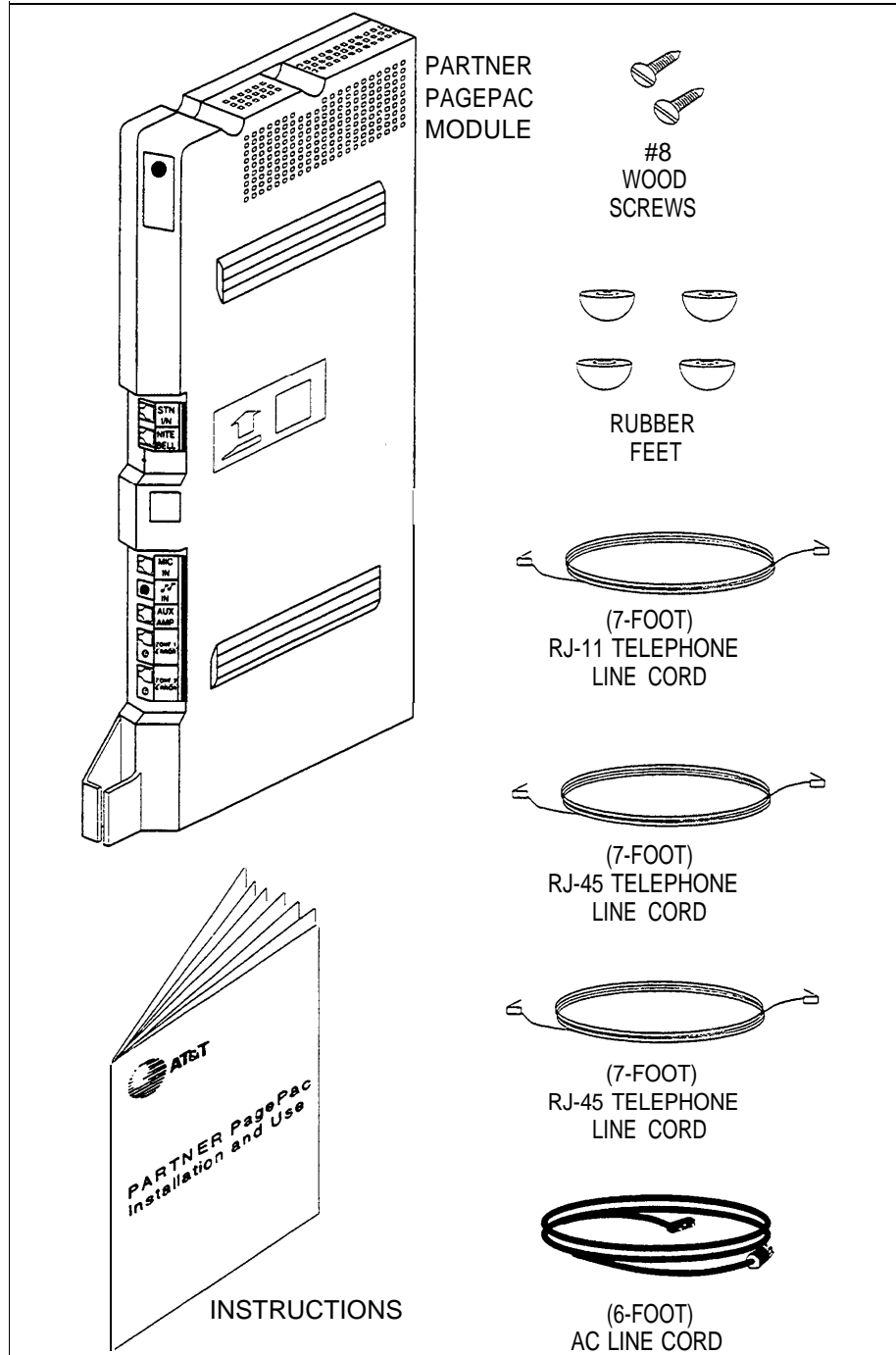

Figure 2-1. Shipping Carton Contents

---

## How is Your Phone System Configured?

---

The first step in the installation process is to determine how your PARTNER Plus or PARTNER II is set up for your particular application. As explained fully in your PARTNER Communications System documentation, several types of modules are available—each of which provides specific features. For instance, a PARTNER Plus with eight telephone lines and 24 telephone extensions would have four 206 modules in addition to the required Processor module. Depending on how these extensions are organized within your business, you may need additional paging capability throughout a large building or even several buildings. The PARTNER PagePac module supports up to three independently controlled and programmed paging zones.

## Important Configuration Information

---

Before actual hardware is installed, it is important to determine what specific components will be used and what options will be selected.

Take time now to make a check list of the parameters for your installation requirements. This will be a useful tool later when installing the hardware and programming parameters into the PARTNER PagePac module.

---

## PARTNER PagePac Module Installation

---

**IMPORTANT:** *Even if your PARTNER Plus/II has an open slot in the carrier, do NOT use it for the PARTNER PagePac module.*

- You can install the PARTNER PagePac module on a wall or on a flat sturdy surface above the floor (such as on a table or desk). Wall mounting is recommended. Complete step 1 below and continue as directed.
- Two #8 screws—for mounting the system on a wooden surface—are included with the system. If you are mounting the system on wallboard, metal or masonry, use the proper fasteners for the wall type and weight of the system (approximately 11 lbs.) Purchase them at any hardware store. You will also need a screwdriver to mount the system. Complete step 1 below and continue as directed.
- For testing the system, you will need a PARTNER system telephone.

*NOTE: Refer to Appendix B for Secondary Surge Protection Information.*



### **CAUTION:**

*Do not connect the AC power cord until the system is fully installed. To prevent damage to the system or installation location, the environmental and electrical conditions must meet the specification on page 1-5.*

# Mounting the PARTNER PagePac Module (Using Mounting Bracket)

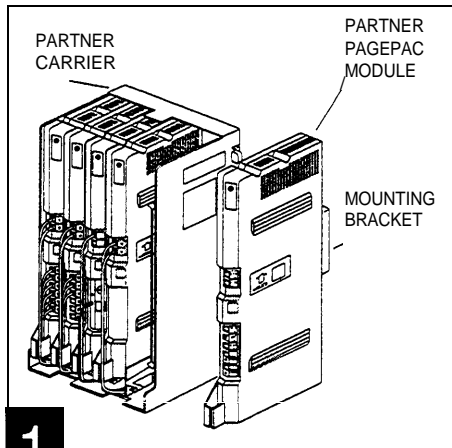

**1**

The PARTNER PagePac module provides a mounting bracket at the back of the unit. The bracket allows the PARTNER PagePac to be mounted to a wall, close to the PARTNER Communication System carrier. Although the PARTNER Pagepac can be mounted next to the carrier, the module cannot be installed directly into the carrier.

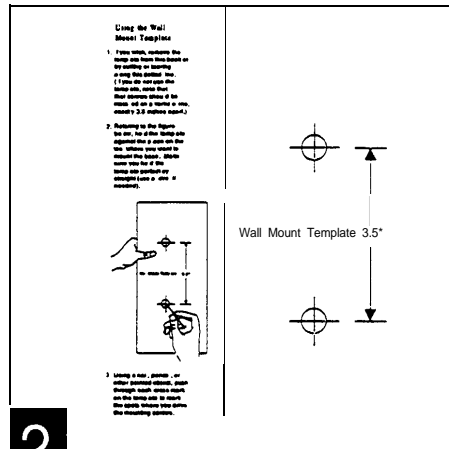

**2**

Use the Wall Mount Template and the included instructions to mark the mounting screw locations on a wall. The Wall Mount Template is located at the end of this section.

**Note:** Mount the PARTNER PagePac within 5 feet of the PARTNER Plus or PARTNER II phone system.

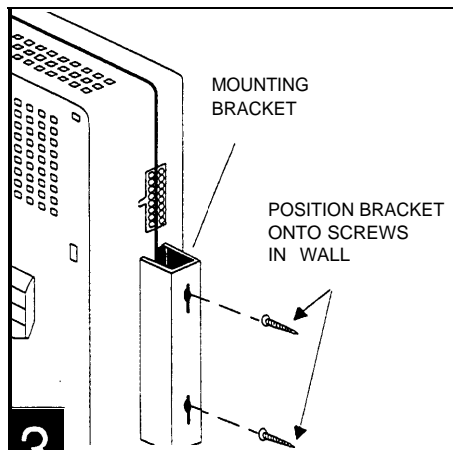

**3**

Use screws appropriate for the type of wall surface. Drive screws so head of screw is approx. 5/16" from wall surface. Position mounting bracket key-hole openings over screw heads. Once bracket is in place onto screws, the PagePac unit should be secure and not easily moved side to side. You may need to tighten screws slightly to provide a better fit to the bracket.

For mounting the PARTNER PagePac **FLAT** onto a wall surface, continue to the next page . . .

If you have completed mounting the PARTNER PagePac using the mounting bracket, turn to page 2-7 for Connecting to AC Power.



## Mounting the PARTNER PagePac Module (Flat onto Wall or Desk)

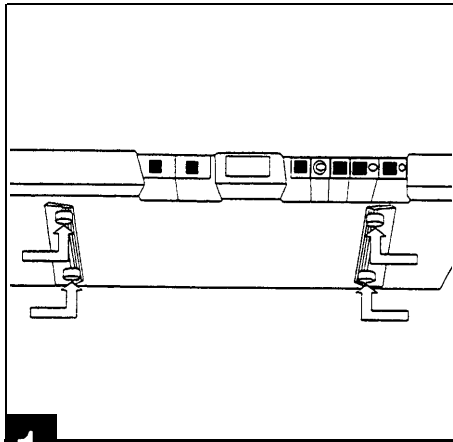

**1** For *either* desk or wall mounting, attach the 4 rubber feet to the mounting tracks on the bottom side of the module.

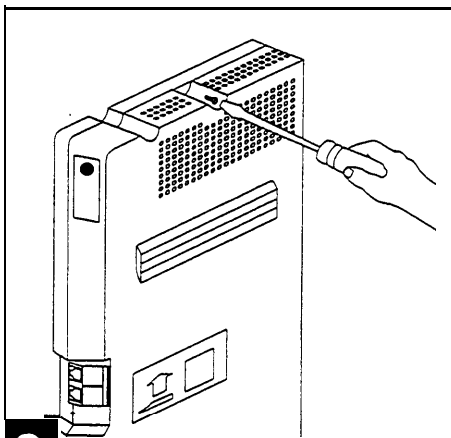

**3** Insert the screws into the screw holes at the top and bottom of the module. Tighten until the rubber feet are snug against the wall. *There must be a 3/8" gap between the wall and the rest of the module.* Do not overtighten—the module will warp and fail to operate.

*MOUNTING FLAT  
ONTO WALL . . .  
go to steps 2 and 3.*

*TABLE MOUNTING...  
skip steps 2 and 3.  
Place the module flat  
on the surface with  
the rubber feet down.  
The module should  
not slide easily.*

Go to "Connecting  
to AC Power" on  
the next page.

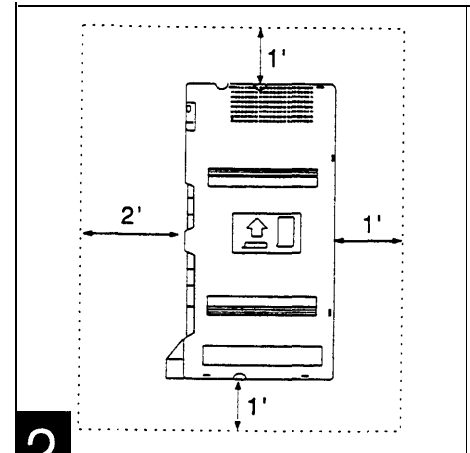

**2** Hold the PARTNER PagePac in place on the wall with the telephone jacks facing left. Leave at least 1 foot clearance at the top, bottom and back, and at least 2 feet in front. This allows you to access the jacks and provides adequate ventilation.

Note: Mount the PARTNER PagePac within 5 feet of the PARTNER Plus or PARTNER II phone system.

Go to next page.

---

## Connecting to AC Power

---

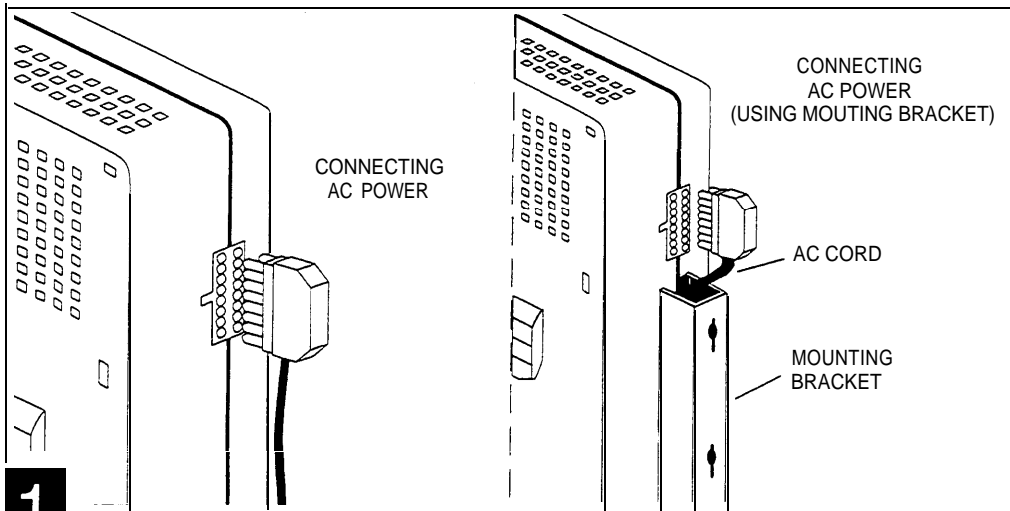

**1** **A** Connect the AC power cord to the AC connector at the back of the PARTNER PagePac module. Press firmly until it clicks as it locks into place.

**B** If the PARTNER PagePac mounting bracket has been used to install the unit to a wall, the AC cord can be fed through the bracket for a cleaner looking installation.

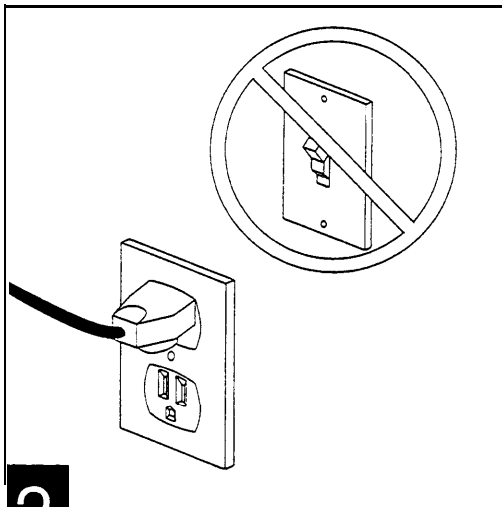

**2** Plug the other end of the power cord into a grounded wall outlet. The outlet *must not* be controlled by a switch.

*The green light below the night bell jack on the module should come on (see Figure 2-2). If it does not, see "Troubleshooting" in Appendix A.*

*This page intentionally left blank*

---

# Wall Mount Template

---

## Using the Wall Mount Template

1. If you wish, remove the template from this booklet by cutting or tearing along this dotted line. (If you do not use the template, note that screws should be installed on a vertical line, exactly 3.5 inches apart.)
2. Referring to the figure below, hold the template against the place on the wall where you want to mount the base. Make sure you hold the template perfectly straight (use a level if needed).

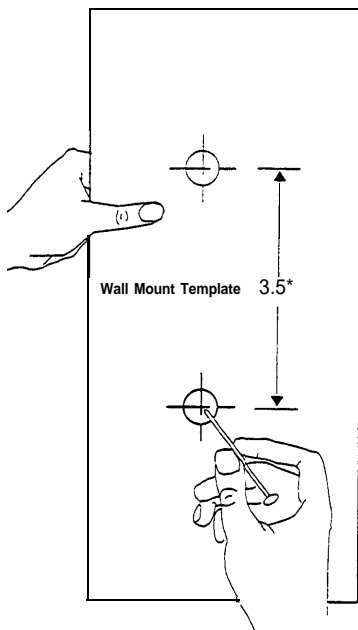

3. Using a nail, pencil, or other pointed object, push through each cross mark on the template to mark the spots where you drive the mounting screws.

## Wall Mount Template (for use with mounting bracket)

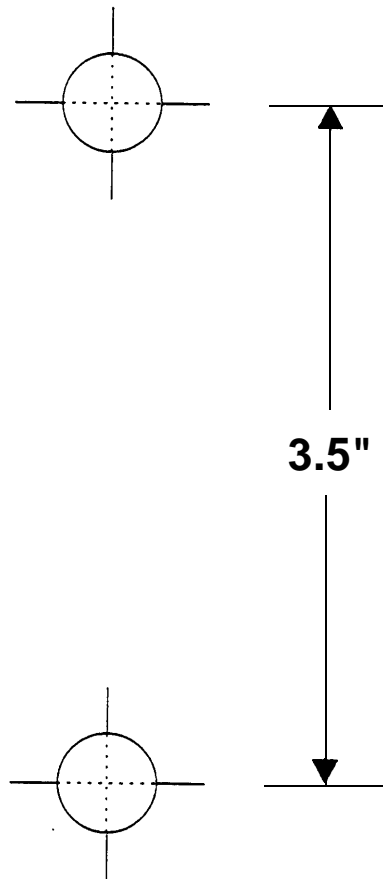

*This page intentionally left blank*

# Selecting the Interface Mode

*NOTE: Dry Loop Mode is the preferred interface method for connection to your PARTNER Plus/n communications system. Refer to pages 2-12 through 2-15 for complete connection information.*

**IMPORTANT:** When using Station Mode all CO lines for that extension must be REMOVED. Refer to your PARTNER Plus/II manual for "Custom Line Assignment Feature" information.

For Station Mode, "Automatic Privacy" should be set for this extension to avoid accidental broadcast of phone conversations.

Once the PARTNER PagePac module has been mounted, the PARTNER PagePac unit can be connected to the PARTNER Plus/n phone system. The PARTNER PagePac RJ-11 STN I/N jack provides for connection to one of the ports on the PARTNER Plus/II system. The PARTNER PagePac module is capable of operating in two primary modes: Station Mode or Dry Loop Mode.

**Dry Loop Mode** permits the PARTNER PagePac paging system to be connected to the Page Port on the PARTNER II and PARTNER Plus system's Processor Module. This option frees up one of the system station ports (extensions). See Table 2-1 and Figure 2-2 for cabling instructions.

**Station Mode** can be used when there is an available station port (extension) that will not be needed by the PARTNER Plus or PARTNER II system. See Table 2-1 and Figure 2-2 for cabling instructions.

**Trunk Adapter Mode** can be used in the event that neither a Station Port nor a Page Port is available. In this case connections are made to one of the PARTNER Plus or PARTNER II system trunk (line) ports and presents a dry loop interface to the PARTNER PagePac paging systems. This option requires the use of an AT&T PARTNER PagePac Trunk Adapter with included power supply (PEC 5335-301). Table 2-1 and Figure 2-2 provide cabling information. See further Trunk Adapter installation instructions on pages 2-13 through 2-15.

Table 2-1. Select One of the Following Interface Mode Cable Connections

Interface Mode (Connect Cable Between)	PARTNER PagePac Module	PARTNER System Module
Dry Loop Mode	STN I/N Port	PAGE Port on Processor Module
Station Model	STN I/N Port	Spare EXTENSION Port
Trunk Adapter Mode <sup>2</sup>	STN I/N Port	Spare LINE Port

<sup>1</sup>When using Station Mode all CO lines for that extension must be **Removed**; set "AUTO PRIVACY" to "Assigned."  
<sup>2</sup>Requires an AT&T PARTNER PagePac Trunk Adapter (PEC 5335-301) to be connected between the PARTNER system and PARTNER PagePac cable connections. (See Figure 2-3, page 2-14.) When using Trunk Adapter Mode, users should set "AUTO PRIVACY" to "Assigned."

---

**IMPORTANT:**  
Dry Loop Mode  
Considerations

- Dry Loop Mode is the preferred method of connection to the PARTNER Plus or PARTNER II Communications system.
- Once the PARTNER PagePac module has been accessed, the unit will remain active until the user takes some action, i.e. “hangs up.”

**IMPORTANT:**  
Station Mode  
Considerations

To ensure full use of "PFT" (Power Failure Transfer) in your PARTNER Plus or PARTNER II phone system during an emergency or power outage conditions when selecting “Station Mode,” these extensions are NOT recommended for use for primary paging access:

- PARTNER Plus system: Stations 10, 11, 16, 22, 28
- PARTNER II system: Stations 10, 11, 16, 22, 28, 34, 40, 46, 52
- Remove all CO lines using the “Line Assignment” feature. Refer to your PARTNER Plus/II *Installation and Use* manual.
- For Station Mode “Automatic Privacy” should be set to “Assigned” for the station designated as the PagePac station interface. Refer to your PARTNER Plus/II *Installation and Use* manual under “Automatic Privacy.”
- During a page, if 30 seconds elapses without any activity, the PagePac system will automatically hang up.
- All pages are limited to a maximum of 2 minutes in duration. The PagePac system will automatically hang up once this time is exceeded.

**IMPORTANT:**  
Trunk Adapter Mode  
Considerations

Do NOT use these Central Office lines for these systems:

- PARTNER Plus system: CO lines 1, 3, 5, 7
- PARTNER II system: CO lines 1, 3, 5, 7, 9, 11, 13, 15
- For Trunk Adapter Mode “Automatic Privacy” should be set to “Assigned.” This avoids users from bridging onto the paging system. Refer to your PARTNER Plus/II *Installation and Use* manual under “Automatic Privacy.”
- A standard telephone can access the paging system by using Direct Line Pickup; refer to your PARTNER Plus/II *Installation and Use* manual.
- If the PARTNER PagePac module has been accessed, the unit will remain active until the user takes some action, i.e. “hangs up.”

# Interface Mode Connections

Once you have decided on the best interface mode for your PARTNER system configuration (Dry Loop Mode, Station Mode, or Trunk Adapter Mode), follow the steps below to make the appropriate interface connections:

*NOTE: Additional installation instructions are provided for Trunk Adapter Mode on page 2-10.*

1. Use a standard 7-foot, 4-pin RJ-11 modular cable (provided) to connect the PARTNER Plus or PARTNER II system to one of the following PARTNER PagePac modules (refer to Table 2-1 and Figure 2-2). Connect the modular cable from the PARTNER PagePac module's "STN I/N" port to:
  - ❶ – Page Port on processor module (for Dry Loop Mode) or
  - ❷ – Station Port (for Station Mode), or
  - ❸ – Trunk Port (for Trunk Adapter Mode).
2. Route cord through bracket at bottom of modules. Leave at least 2 feet of slack so that you can easily reconnect cord during replacement.
3. Plug the PARTNER power cord into the AC outlet, 110V/60 Hz. Use the special power cord (supplied) to connect the PARTNER PagePac unit to the selected AC outlet.

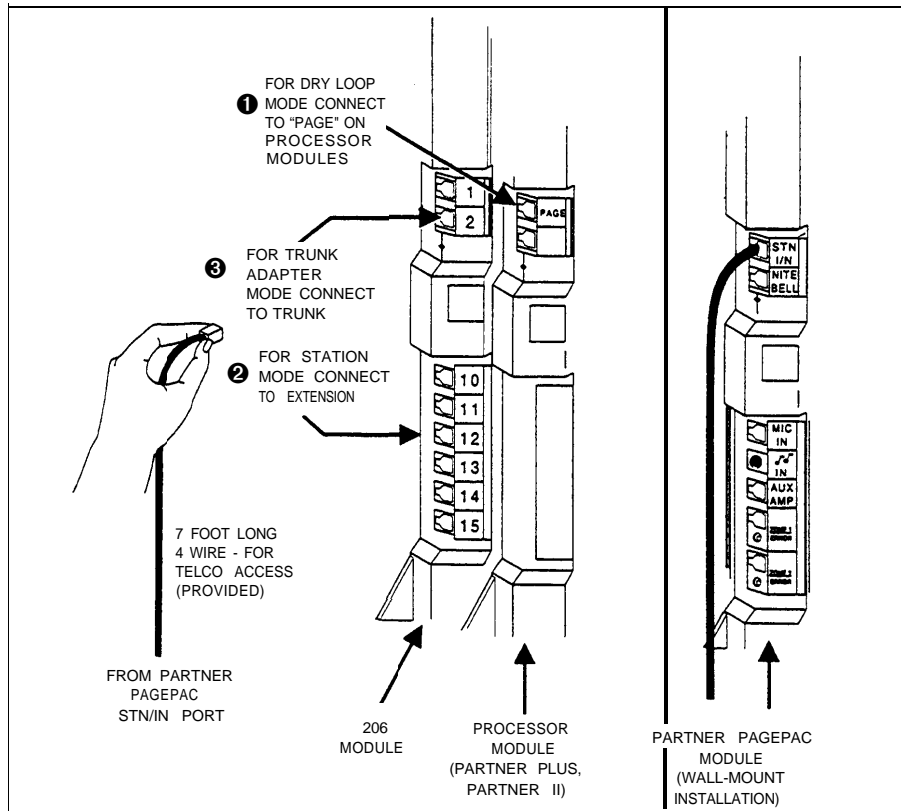

Figure 2-2 Cable Connections for Selected Interface Mode



---

## Trunk Adapter Connections (Trunk Adapter Mode Only)

---

If Trunk Adapter Mode has been selected as the best interface connection for your requirements (pages 2-7 and 2-8), continue with the following procedure:

Required materials:

- ❶ – AT&T PARTNER PagePac Trunk Adapter (PEC 5335-301)
- ❷ – Standard modular telephone cord (7 feet, provided)

Follow the steps below to install the AT&T Trunk Adapter (see Figure 2-3):

1. Connect the PARTNER PagePac Trunk Adapter modular cord to the PARTNER PagePac module STN/IN port.
2. Connect the PARTNER PagePac Trunk Adapter jack J2 to the available Trunk (Line) Port on the selected PARTNER system module.
4. Route cord(s) through bracket at bottom of modules. Leave at least two feet of slack so you can remove modules.
5. Connect the PARTNER PagePac Trunk Adapter 24 volt power supply (supplied) to AC power.

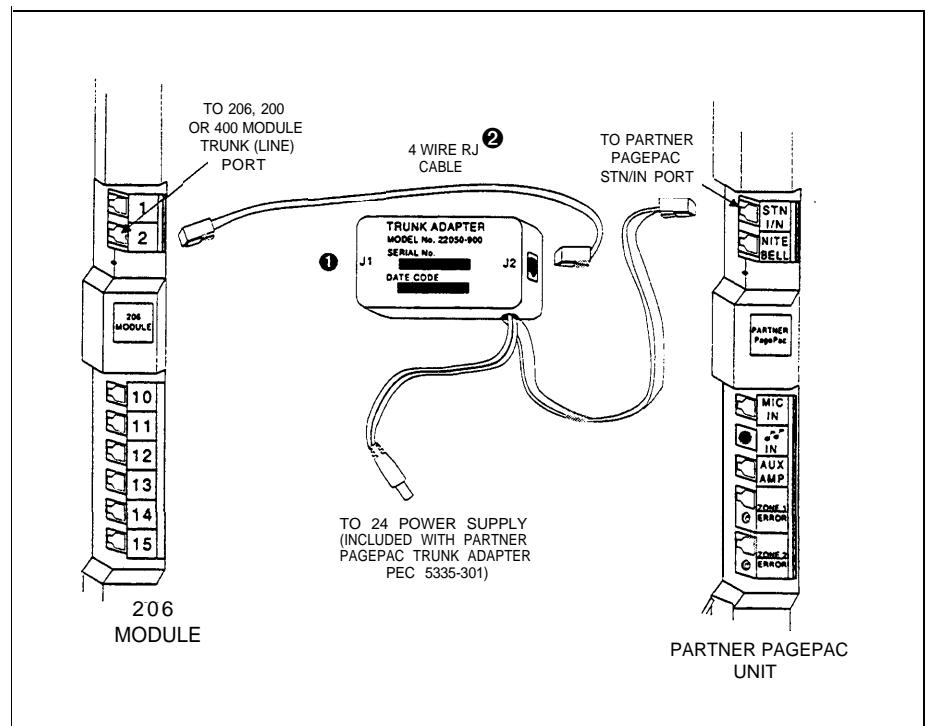

Figure 2-3 Trunk Adapter Installation for PARTNER PagePac Module

---

## PARTNER PagePac Telephone Access

---

Establishing telephone access provides a means to *talk to* the PARTNER PagePac unit for programming and accessing the various features.

If you have configured your PARTNER PagePac system:

**For Dry Loop Mode** (connection to Page Port) you will need to dial [INTERCOM] [7] [0].

**For Station Mode** operation, you will need to dial the extension number connected to the PARTNER PagePac paging system. For example, if you have configured the PARTNER PagePac paging system with a cable connecting from the PARTNER PagePac STN I/N port to extension 20 of a PARTNER Plus system module, you would dial [INTERCOM] [2] [0] the first time you wish to access PARTNER PagePac features and programming capabilities.

**For Trunk Adapter Mode** you will need to select the trunk which is connected to the PARTNER PagePac unit by pressing the appropriate [LINE] button. For standard telephone access, use *Direct Line Pickup*.

Each input to the PARTNER PagePac module has its own priority. If more than one input is active at the same time, the signal with the highest priority will take precedence over all the others. In addition, if a higher-priority input becomes active while a lower-priority input is being processed, the PARTNER PagePac module will abandon the lower-priority input in favor of a higher priority input.

The input priorities, from highest to lowest, are as follows:

- Microphone input
- Station input
- Door input
- Night Bell input
- Music input

### Continuing Installation ...

*NOTE: Once you have completed the Page/Speaker Mode installation steps in Section 3, you can use the Quick Test procedure at the end of that section.*

Your PARTNER PagePac should now be installed (mounted to a wall or placed onto a desk), and your PARTNER PagePac module has been connected directly to your PARTNER Plus or PARTNER II phone system.

Section 3 continues the installation steps for PAGE/SPEAKER MODE and covers Zone 1 & 2 remote amp configurations along with Zone 3 auxiliary paging features. At the end of Section 3 is a *Quick Test* to ensure your installation has been successful.

Section 4 deals exclusively with DOORSPEAKER MODE and what is necessary to configure Zones 1 or 2 for doorspeaker functions. Section 4 also provides a *Quick Test* to ensure proper installation.

# 3

---

# PARTNER PagePac Paging Access

---

## Primary Paging Zones (Zones 1 and 2)

Refer to Section 4 for Doorspeaker Mode Installation.

Refer to Section 5 for adding Night Bell service.

The PARTNER PagePac can be configured differently depending on your particular situation. Two primary zones (Zone 1 and Zone 2) can be individually configured for Page/Speaker Mode, Doorspeaker Mode, or Remote Amplifier Mode.

Both zones 1 and 2 provide a 4 watt on-board amplifier power switch to drive voice coil (3.4V) speakers in Page/Speaker Mode and Doorspeaker Mode. Each zone provides a RJ-45 jack which supplies an *audio pair* (which is used in all modes), a contact closure pair (used for the Doorspeaker and Remote Amplifier Modes) and four wires for the Door Bell and Door Ajar inputs (used in Doorspeaker Mode). The primary paging zones provide paging, hands-free talkback (programmable), music, and tone output on the audio pair.

## Talkback Capabilities

---

NOTE: Auxiliary paging zone will NOT support talkback.

See Table 3-1 for available speakers.

The PARTNER PagePac has the unique ability to provide individuals with the ability to talkback over selected speaker zones 1 or 2. "Hands-Free" talkback is available in both Page/Speaker and Doorspeaker Modes. Refer to Section 6 for complete programming information for this feature.

## Remote Amplifier Mode (Zones 1 and 2)

---

Refer to Figures 3-2 and 3-3.

NOTE: PagePac 6 Plus cannot be used as a remote amplifier.

In "Remote Amplifier Mode," the Audio Pair provides the signal inputs to the amplifier. and the control closure pair is used to operate the Page/Music switch on the amplifier. The Door Bell and Door Ajar inputs are ignored.

A Remote Amplifier zone provides the same paging features as a Page/Speaker zone. The chief difference is that the PARTNER PagePac module closes the relay on the control closure pair when it is presenting a signal (Page, Tone, or Music) on the audio pair, and opens the relay contacts when the zone is idle (see Figure 3-1 for example installation).

## Auxiliary Paging Zone (Zone 3)

---

NOTE: Zone 3 provides a 0 dBm signal for a Remote Amplifier.

NOTE: The Auxiliary Paging Zone (Zone 3) cannot be configured in Doorspeaker Mode.

NOTE: PagePac 6 Plus cannot be used as an auxiliary amplifier.

Zone 3 of the PARTNER PagePac module is called the *Auxiliary Paging Zone*. This Zone is intended for connection to a paging amplifier, such as the AT&T AmpliCenter series. The Auxiliary Paging Zone operates in the same fashion as a Primary Paging Zones (zones 1 and 2) configured in Remote Amplifier mode. The chief difference is that, unlike Zones 1 and 2, Zone 3 does not provide an on-board 4-watt amplifier paging or the ability to provide talkback.

**CAUTION:**

For remote amplifier locations, a PageGuard (P/N 22050-930) or PARTNER IROB (PEC 60612) may be required for protection from potential telephone network electrical disruptions (refer to Appendix B)

A remote amplifier can be within the same building as the PARTNER PagePac module or at a remote location. The auxiliary paging zone port is located at the front of the PARTNER PagePac module and is a modular connector labeled AUX AMP (see Figure 1-1). This zone can be used for paging, background music, and tones. The 0 dBm output is suitable for driving an amplifier, but is not suitable for direct connection of the speaker. The AUX AMP port provides two leads for the audio pair and two leads for contact closure (see Figure 3-1).

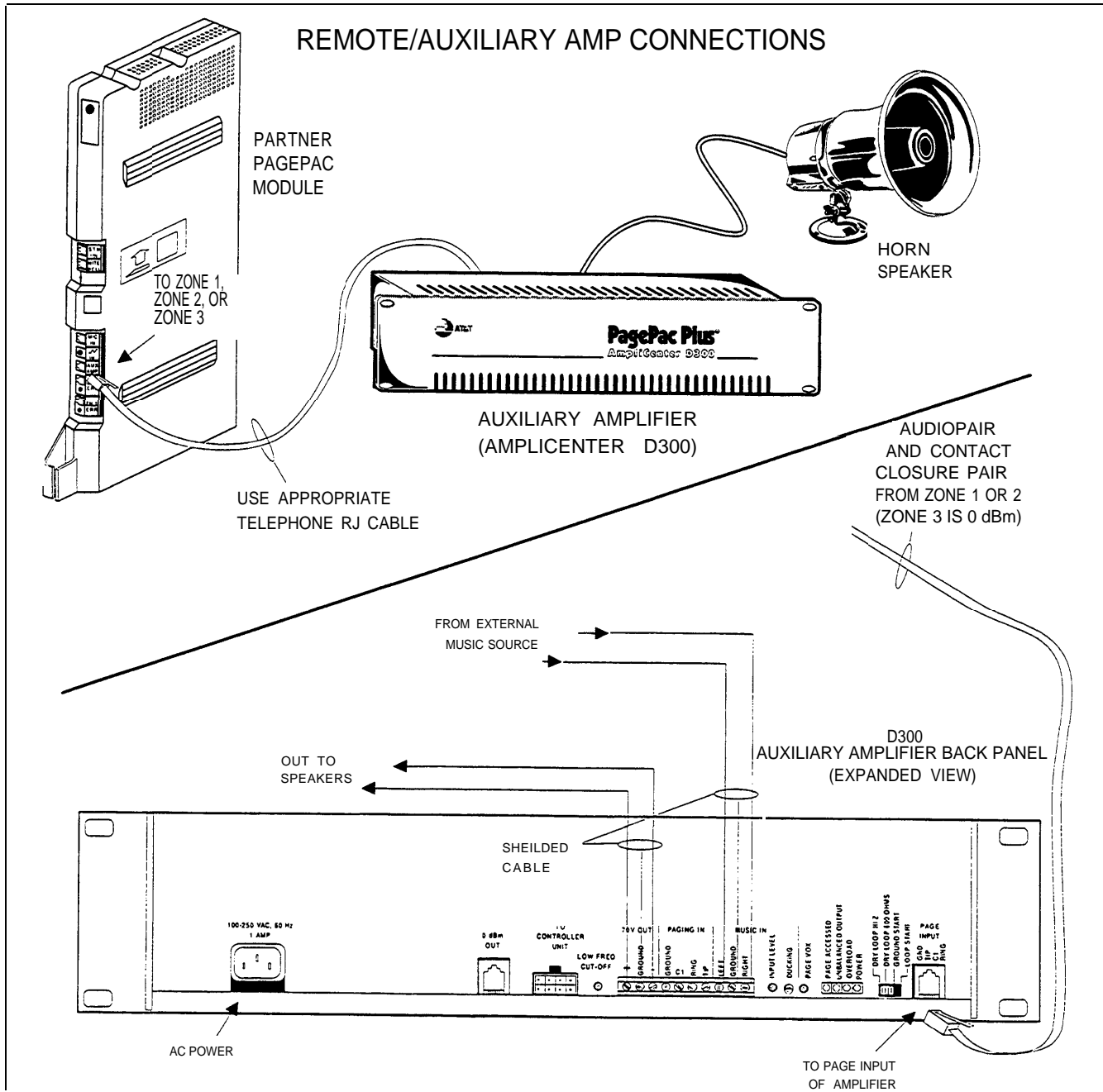

Figure 3-1 PARTNER PagePac Connections ( Zones 1, 2, or 3) to a Remote Amplifier

## Connecting Speakers

*NOTE: Use Voice Coil speakers only.*

Standard voice coil ceiling speakers (indoor ceiling-type or P-Tec) and horn speakers may be used with the PARTNER PagePac module. Use only voice-coil 3.4 Vrms type speakers and use only the appropriate model speaker for your situation (see Table 3-1). It is important not to exceed the number of speakers or speaker run length maximums shown in Table 3-2 below.

Table 3-1 Recommended Speakers

Paging Area	Mounting Location	Speaker Type (Voice Coil)	AT&T Order No.
<b>Open or Closed Office Areas, Conference Room, Etc.</b>	On Wall or Ceiling	Universal Cabinet or P-TEC	PEC 5330-105 PEC 5330-100
	Above Ceiling	Recessed Ceiling or P-TEC	PEC 5330-215 PEC 5330-100
<b>Hallways</b>	On Wall or Ceiling	Universal Cabinet	PEC 5330-105
<b>Private Office</b>	Placed on Desk	Desktop	PEC 5330-110
<b>Front/Back Door*</b>	On Wall	Door Speaker	PEC 5330-120
<b>Open Industrial Area or Outdoors</b>	On Wall or Pole at Least 15 ft. Above Ground	1 Watt Horn w/ taps	PEC 5331-100

*NOTE: In some situations you may be able to extend a run farther than 600 feet, by using fewer speakers and/or larger diameter wire.*

*NOTE: Listed speakers are capable of Talkback.*

\*NOTE: Doorspeaker cable runs should use the "Home Run" method and should not exceed 1500 feet.

Table 3-2 Speaker Limitations

PARTNER PagePac Paging Systems	Standard Indoor Speakers Per Zone (Zones 1 and 2)	Horn Speakers Per Zone (Zones 1 and 2)
<b>Total Speakers</b>	12	3 to 16**
<b>Speakers Per Run*</b>	4	1
<b>Maximum Length of Speaker Run (24 AWG Copper Wire)</b>	600 Feet	300 Feet
<p>*A run is a line of one or more speakers that connects directly to PARTNER PagePac module. If using both horns and standard speakers, each horn counts as four standard speakers.</p> <p>**Depends on 1-Watt Horn Speaker tap settings - see documentation provided with speaker.</p>		

*NOTE: Speaker quantities to the right DO NOT apply to Zone 3, which can drive a remote amplifier which is only limited by the amplifier power output (wattage).*

*NOTE: 4 watts are available per zone.*

## Run Speaker Cable

There are two methods of wiring speakers: from speaker-to-speaker and Home Run (refer to Figure 3-2). When wiring speaker-to-speaker, cable is run from the PARTNER PagePac module to the nearest speaker location, from that location to the next, and so on, until all locations are connected. When wiring Home Run, cable is run from the PARTNER PagePac module to each speaker location. A combination of both methods may be used, but the maximum distance for each cable run is 600 feet. Recommended cable size is 24-22 AWG minimum with "shielded" cable for all speakers with Talkback.

## Connect Speaker Cable

When all speakers have been installed, connect speaker cable using one of the methods described above. Each zone must have its own dedicated speaker cable run. Refer to Figures 3-2 and 3-3, along with the installation Instructions provided with your speakers for specific installation procedures.

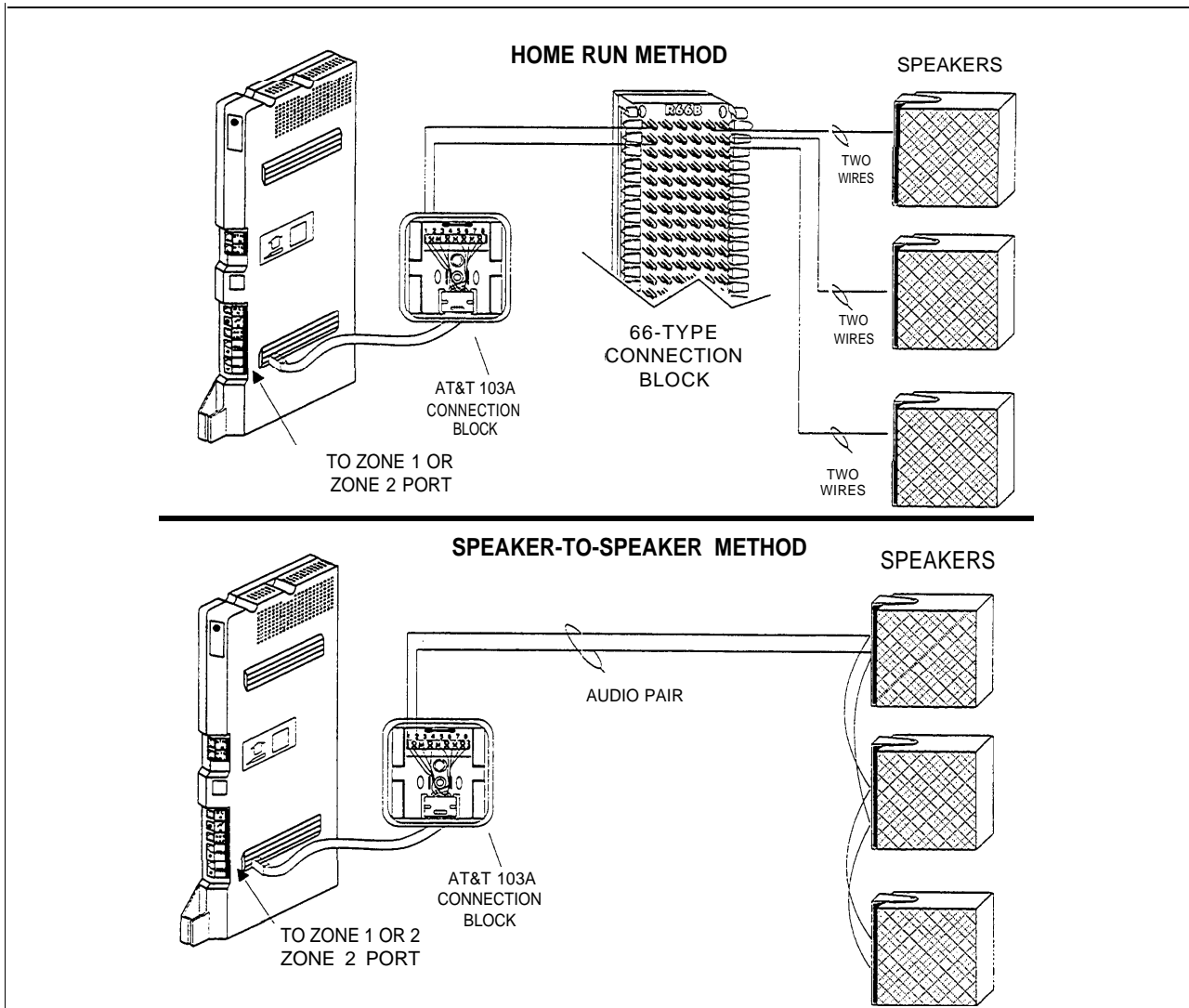

Figure 3-2 Speaker Run Methods

# Connection Block

*NOTE: Auxiliary Port can utilize an RJ-11 modular cable direct to PagePac or AmplCenter RJ-11 jack. No Connection block is needed.*

Zones 1 and 2 on the PARTNER PagePac module have an RJ-45 modular jack interface. To connect the various audio pair wires (and contact closure pair wires), it is recommended you use a standard full-modular 8-pin cable to connect from the PARTNER PagePac module to an AT&T 103A block, which in turn can connect to a 66-type connection block if needed. Figure 3-3 provides a typical wiring example and includes the pinout connections for the RJ-45 cable, as well as the 103A block terminal pinouts.

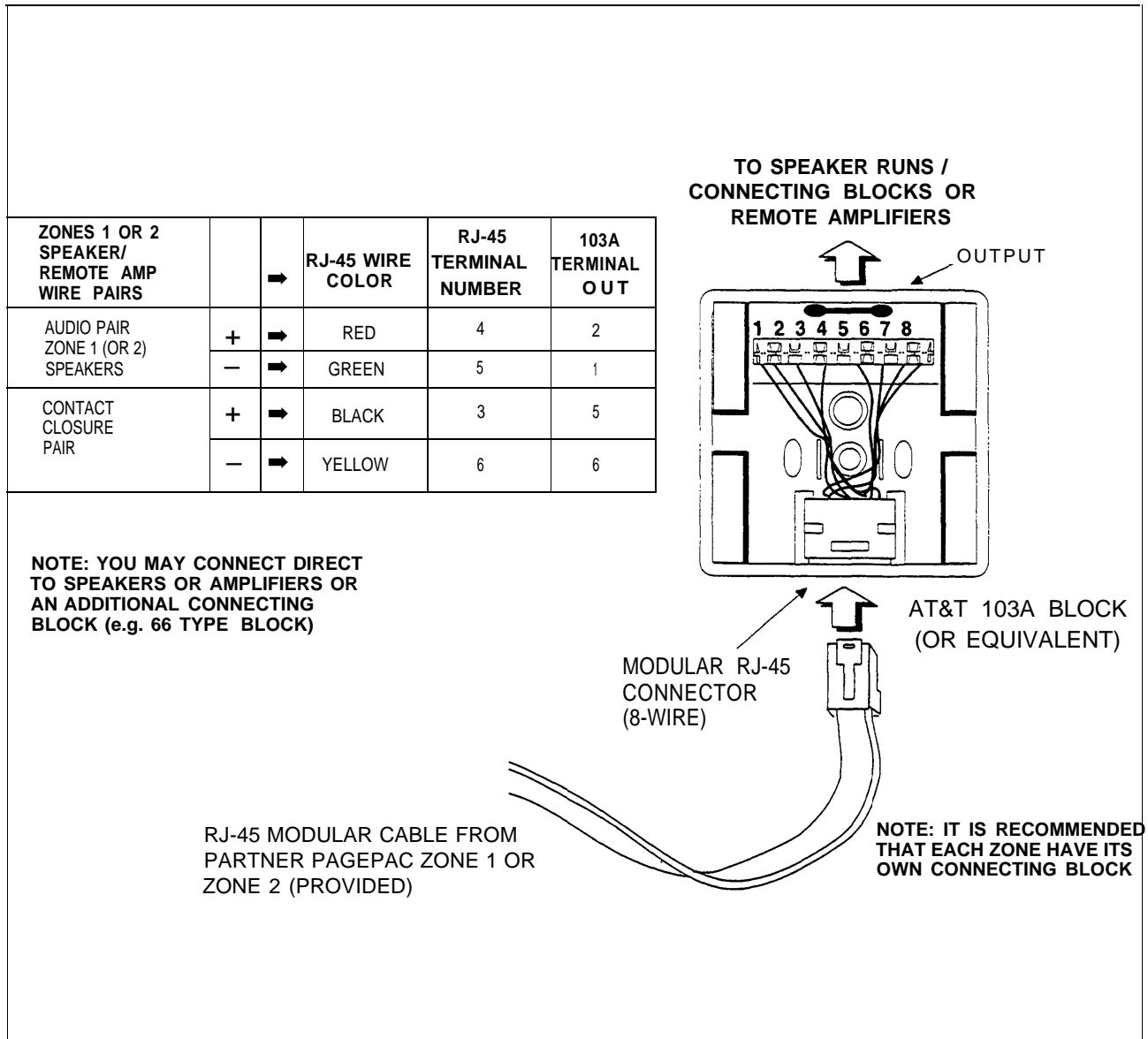

Figure 3-3 Example Speaker / Remote Amplifier Connection Block Wiring



---

## Quick Test (Paging to Loudspeakers)

---



*NOTE: If tests do not result in proper paging over loudspeakers, refer to "Troubleshooting" in Appendix A.*

*A Remote Amp zone, refers to a primary zone configured as a remote amp (with a separate amp). This is output (fixed) from AUX port.*

- At this point your PARTNER PagePac module has been installed along side your PARTNER Plus or PARTNER II phone system. In addition, you should have installed the necessary speakers, connecting blocks, and wiring within your business.
- The following test will ensure your PARTNER PagePac module is operating correctly by making a page over the loudspeakers to zone 1, zone 2, and zone 3 (remote amp).

### **You Will Need:**

A PARTNER System telephone (do NOT use a standard telephone).

### **To Access the PARTNER PagePac Module**

**For Dry Loop Mode** (connection to Page Port) you will need to dial:

[INTERCOM] [7] [0].

**For Station Mode** operation, you will need to dial [INTERCOM], followed by the extension number connected to the PARTNER PagePac paging system. For example, if you have configured your PARTNER PagePac paging system with a cable connecting from the PARTNER PagePac STN I/N port to extension 20 of the PARTNER Plus system module, you would dial [INTERCOM] [2] [0] the first time you wish to access PARTNER PagePac features and programming capabilities.

**For Trunk Adapter Mode** you will need to select the trunk which is connected to the PARTNER PagePac unit by pressing the appropriate [LINE] button. For standard telephone access, use *Direct Line Pickup*.

### **Zone 1 Test (For NON-remote amp configurations)**

1. Dial [1] (for zone 1 page).  
*You should hear the pre-announcement tone (3/4 second tone) out of the zone 1 loudspeakers. All other zones will be quiet.*
2. Speak into the telephone transmitter.  
*You should hear your voice over the loudspeakers.*
3. Dial [#] (to return to PARTNER PagePac dial tone).  
*You should hear the PARTNER PagePac dial tone in the receiver.*

### **Zone 2 Test (For NON-remote applications)**

4. Dial [2] (for zone 2 page).  
*You should hear the pre-announcement tone (3/4 second tone) out of the zone 2 loudspeakers. All other zones will be quiet.*
5. Speak into the telephone transmitter.  
*You should hear your voice over the loudspeakers.*

- 
6. Dial **[#]** (to return to PARTNER PagePac dial tone).  
*You should hear the PARTNER PagePac dial tone in the telephone receiver.*

#### **Zone 3 Test (automatically is set for remote amp)**

*NOTE: Zone 3 will always be configured as a remote zone and does not need to be programmed as a remote zone.*

7. Dial **[3]** (for zone 3 page).  
*You should hear the pre-announcements tone (3/4 second tone) out of the zone 3 loudspeakers. All other zones will be quiet.*
8. Speak into the telephone transmitter.  
*You should hear your voice over the loudspeakers.*
9. Dial **[#]** (to return to PARTNER PagePac dial tone).  
*You should hear the PARTNER PagePac dial tone in the telephone receiver.*

#### **Zone 1 or 2 Test (Configured as a Remote Amp)**

*NOTE: If paging system does not respond as indicated, refer to "Troubleshooting", Appendix A.*

If zones 1 and/or 2 have been configured as a remote amp zone, you will need to tell (program) this to the PARTNER PagePac module before you can page to those zones.

#### **Quick Programming**

1. Dial **[\*] [\*]** (to start programming).  
*You should hear a different dial tone in the telephone receiver.*
2. Dial **[6] [0]** (for type of zone).  
*You should hear two beeps followed by the programming mode dial tone in the telephone receiver.*
3. Dial the zone number you wish to program as a remote zone (1, 2).  
*You should hear two beeps (again) in the telephone receiver.*
4. Dial **[3]** (selecting a remote amp).  
*You should hear three beeps in the telephone receiver, followed by the programming mode dial tone.*

#### **Test**

5. Dial **[#]** (to return to PARTNER PagePac dial tone).  
*You should hear the PARTNER PagePac dial tone in the telephone receiver.*
6. Dial the zone number you have configured as a remote amp (1 or 2).  
*You will hear the pre-announcement tone over the selected zone's loudspeakers.*
7. Speak into the telephone transmitter.  
*You should hear your voice over the loudspeakers.*

*NOTE: If another zone has been configured as a remote amp zone (zone 1 or 2) repeat the above steps but change the zone number dialed in step 6.*

---

Doorspeaker Mode Installation

4

---

# AT&T Doorspeaker

---

*NOTE: Zone 3 does not support Doorspeaker Mode.*

**\*IMPORTANT:**  
*Electronic strikeplate and door ajar equipment and installation is customer provided.*

The PARTNER PagePac module is compatible with the AT&T Doorspeaker (PEC 5330-120) and will also provide door ajar\*, electronic strikeplate\* and door bell\* support from either zone 1 or zone 2. The AT&T Doorspeaker can be surface or flush mounted to a wall at the front or rear entrance of your business.

When the Doorspeaker button (see Figure 4-1) is pressed, the PARTNER PagePac module will alert inside personnel that the door needs attention by either ringing an extension (Ringdown Mode) or providing a tone over the paging system (Door Alert Mode). In addition, once communications have been made with the doorspeaker, the door can be remotely opened by inside personnel by entering the appropriate touch-tone code (refer to Section 7).

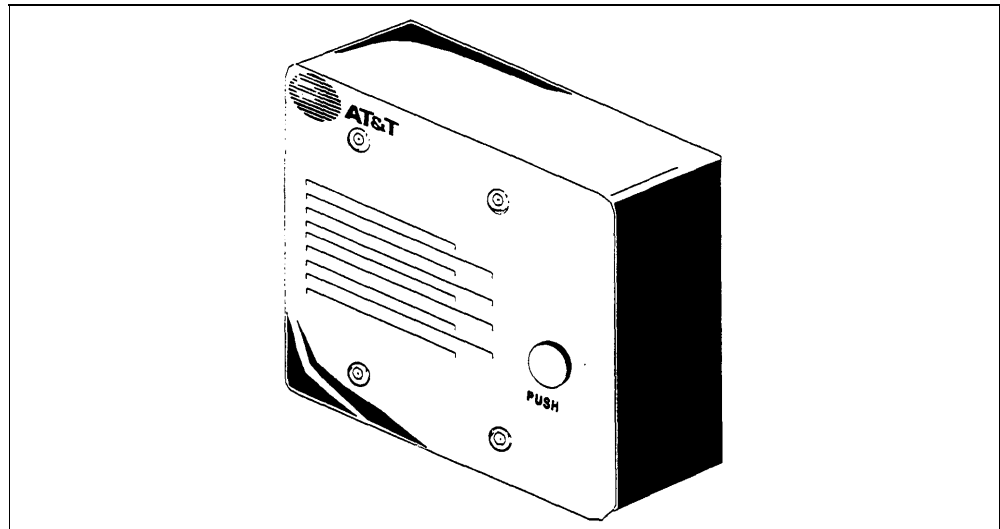

Figure 4-1 AT&T Doorspeaker—PEC 5330-120

## **IMPORTANT:** Door Action Considerations

- The PARTNER Plus Doorphone, PEC 5324-003, will not work.
- Ringdown Mode is only supported in Station Mode configuration.
- Door Alert Mode is available in all three configuration modes: Dry Loop Mode, Station Mode, and Trunk Adapter.

# Connection Blocks

The PARTNER PagePac module provides an 8-pin (four pair) RJ-45 jack for both zone 1 and zone 2. To connect the various audio pair wires, contact closure pair wires, and door bell and door ajar pair wires to the PARTNER PagePac module's RJ-45 jack, it is recommended you use a standard full-modular 8-pin cable to connect from the PARTNER PagePac module to an AT&T 103A block (see Figure 4-2). The 103A block can in turn be connected (via 22-24 AWG wire) to an AT&T 66-type block (see Figure 4-2 for an example Doorspeaker installation).

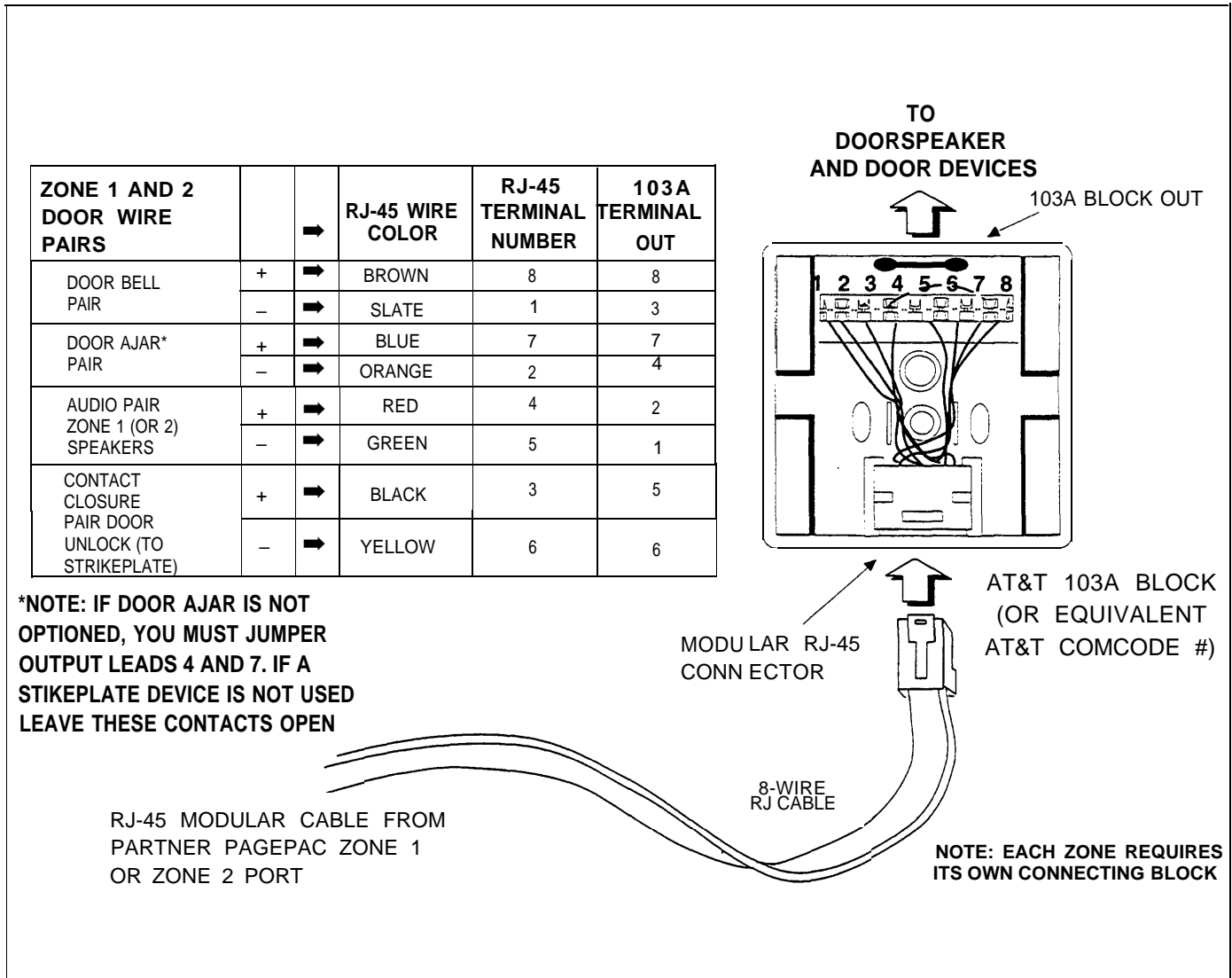

Figure 4-2 AT&T 103A Connection Block Used For Doorspeaker Installation

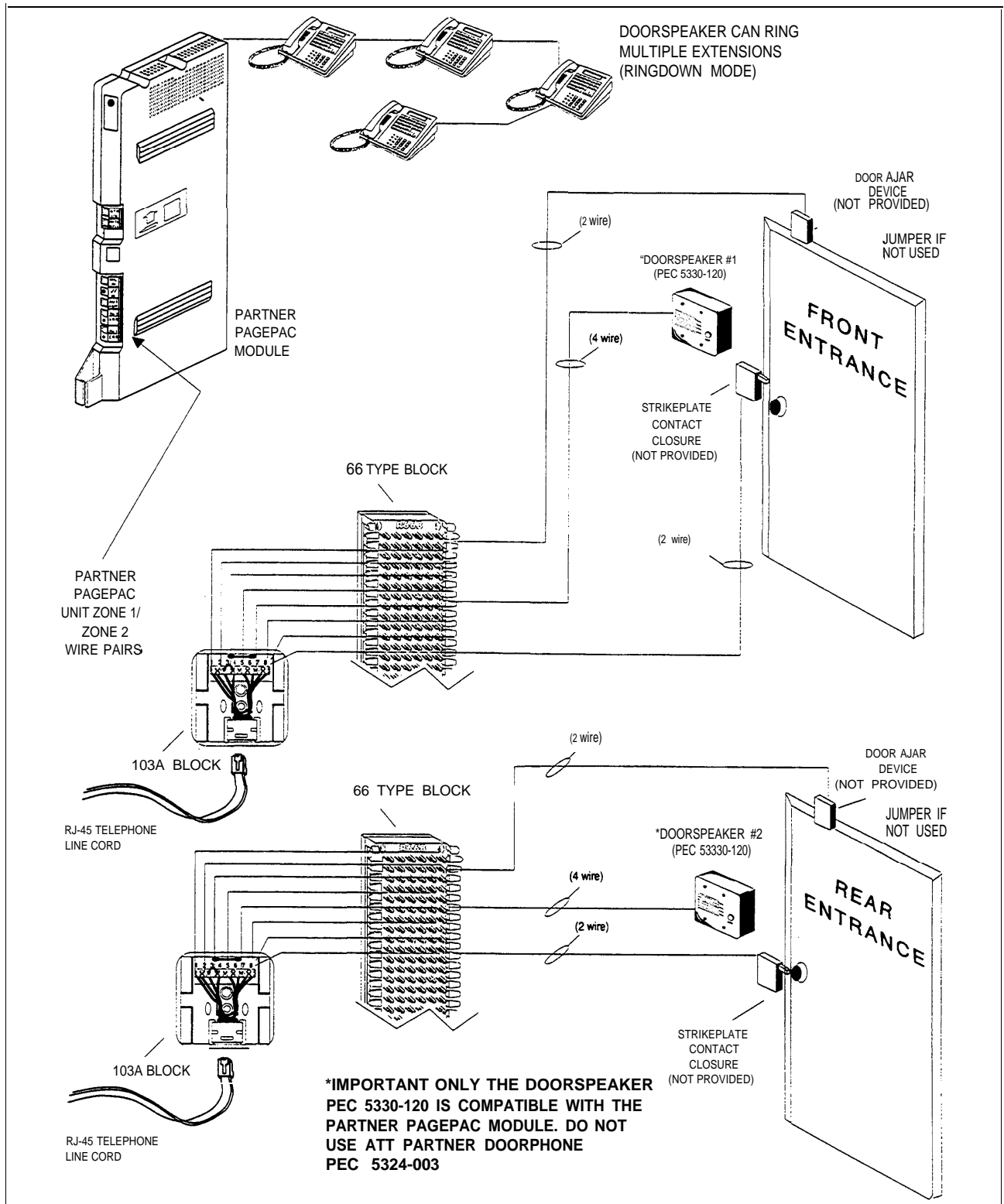

Figure 4-2 PARTNER PagePac Module Connections to Remote Doorspeaker Equipment

---

## Quick Test (Doorspeaker Equipment)

---



*NOTE: If tests are not as expected, refer to "Troubleshooting" in Appendix A.*

- At this point your PARTNER PagePac module has been installed along side your PARTNER Plus or PARTNER II Phone system and you have completed the Page/Speaker installation steps outlined in Section 2. In addition, you should have installed the necessary Doorspeaker equipment (Doorspeaker, electronic strikeplate, door ajar device, connecting blocks, and wiring) within your business.
- The following test will ensure your PARTNER PagePac is operating correctly by providing two-way communications with a Doorspeaker, opening a doors strikeplate contact closure and determining if a door ajar device has been activated.

### **You Will Need:**

A PARTNER System telephone and another person to activate the Doorspeaker.

Zone 1 and/or Zone 2 (Configured for *Doorspeaker Mode*)

If zone 1 or 2 has been configured as a Doorspeaker Mode zone, you will need to tell (program) this to the PARTNER PagePac module.

### **To Access PARTNER PagePac Module**

**For Dry Loop Mode** (connection to Page Port) you will need to dial:

[INTERCOM] [7] [0].

**For Station Mode** operation, you will need to dial [INTERCOM], followed by the extension number connected to the PARTNER PagePac paging system. For example, if you have configured your PARTNER PagePac paging system with a cable connecting from the PARTNER PagePac STN I/N port to extension 20 of the PARTNER Plus system module, you would dial [INTERCOM] [2] [0] the first time you wish to access PARTNER PagePac features and programming capabilities.

**For Trunk Adapter Mode** you will need to select the trunk which is connected to the PARTNER PagePac unit by pressing the appropriate [LINE] button. For standard telephone access, use *Direct Line Pickup*.

You should hear the PARTNER PagePac dial tone in the telephone receiver.

### **Quick Programming**

1. Dial [\*] [\*] (to start programming).  
*You should hear a different dial tone in the telephone receiver.*
2. Dial [6] [0] (for type of zone).  
*You should hear two beeps in the telephone receiver.*

**IMPORTANT:**  
*Only Doorspeaker PEC 5330-120 is compatible with the PARTNER PagePac module. Do NOT use AT&T PARTNER Plus Doorphone PEC 5324-003 (there should be NO LED on the doorspeaker face plate).*

---

*To Program/Test a second Doorspeaker, repeat these steps with the appropriate zone number.*

3. Dial the zone number you wish to program as a Doorspeaker Mode zone (1, 2).  
*You should hear two beeps followed by the programming dial tone in the telephone receiver.*
4. Dial [2] (to select Doorspeaker Mode).  
*You should hear three beeps followed by the programming dial tone.*

**Test**

5. Dial [#] (to return to PARTNER PagePac dial tone).  
*You should hear the PARTNER PagePac dial tone in the telephone receiver.*
6. Hang up.
7. Have your assistant press the Doorspeaker button (for selected zone 1 or 2).

*The person at the door should hear the door alert tone from the Doorspeaker.*

*You (the person at the telephone) should hear the door alert tone over the other zones' loudspeakers.*

*NOTE: The default Doorspeaker action is Door Alert Mode; refer to Section 6 for Ringdown Mode information.*

*NOTE: To access the PARTNER system, refer to the previous page.*

8. Pick up the phone receiver and access the PARTNER system.  
*You should hear in the telephone receiver 1 beep if the button at door 1 has been pressed, or 2 beeps if the button at door 2 has been pressed.*

*You should now have two-way communications with the Doorspeaker.*

*Refer to Section 6 for programming options.*

9. Dial [O] [P] [E] [N] (to open remote door; only if strikeplate is used).

*The door's electronic strikeplate should open so the person at the door can enter.*

*Refer to Section 7 for complete operating information.*

10. If the person at the door leaves the door open more than 30 seconds, a door ajar alert can be heard over the page/speaker zones.



# 5

---

# Installing a Music Source

*NOTE: If you use equipment that rebroadcasts music or other copyrighted materials, you may be required to obtain a license from a third party such as ASCAP or BMI.*

The PARTNER PagePac module provides a music source interface (impedance of 100k  $\Omega$ ) for background/foreground music applications. Use a standard audio cable with RCA jacks. Connect the AT&T FM (PEC 5335-510) or AM-FM (PEC 5335-505) music source from the music source *output* to the *music input* (RCA jack) on the PARTNER PagePac module (see Figure 5-1).

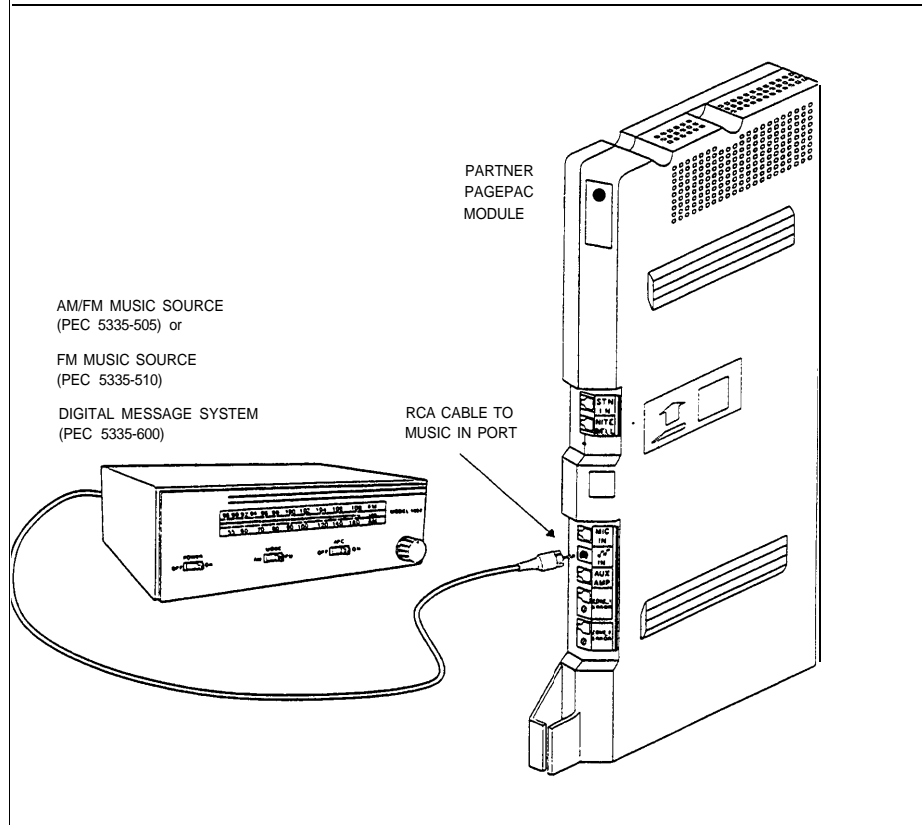

Figure 5-1. Connections for External Music Source

# Volume Adjustment (Page/Music)

Refer to Section 6 for volume output levels.

*NOTE: Music can be played over primary zones (zones 1 and 2) and the auxiliary zone (zone 3).*

Volume level is adjusted from a PARTNER system telephone (Figure 5-2). Eight different volume levels can be selected by entering the proper DTMF code (3 dB per key stroke). The PARTNER PagePac default background music level is set at 4 and the default page level is set at 6 (refer to Table 6-3). Programming instructions for changing the music/page volume levels are provided in Section 6. Page/Music volume adjustment function will work only for zones 1 and 2. Volume levels for Zones 1 and 2, and for Page or Music, can be adjusted separately.

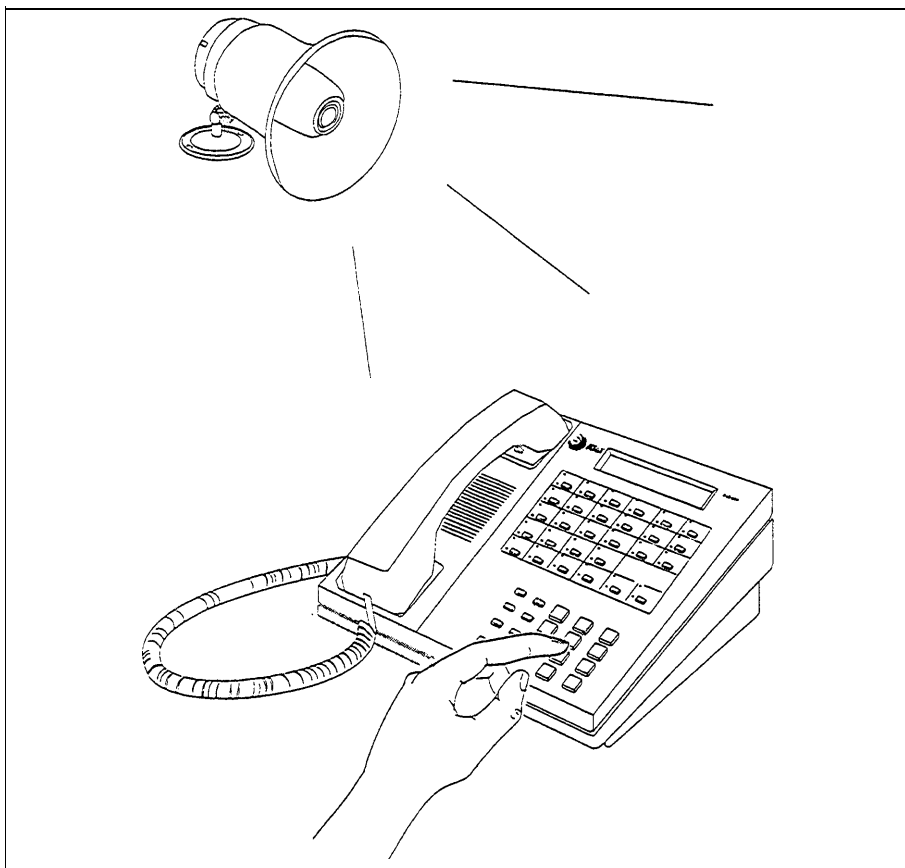

Figure 5-2. Volume Level Adjusted From PARTNER Phone

# Using a Microphone with the PARTNER PagePac Module

Many installations, such as restaurants and retail stores, require microphone access for paging. The AT&T Microphone (PEC 5335-400) provides a switch activated ON/OFF contact closure, and will install easily to the modular port at the front of the PARTNER PagePac module labeled MIC IN. Microphone access can be configured for a per zone page or all call (all zone) page. Microphone enable/disable parameters are set in the PARTNER PagePac programming mode (see Section 6).

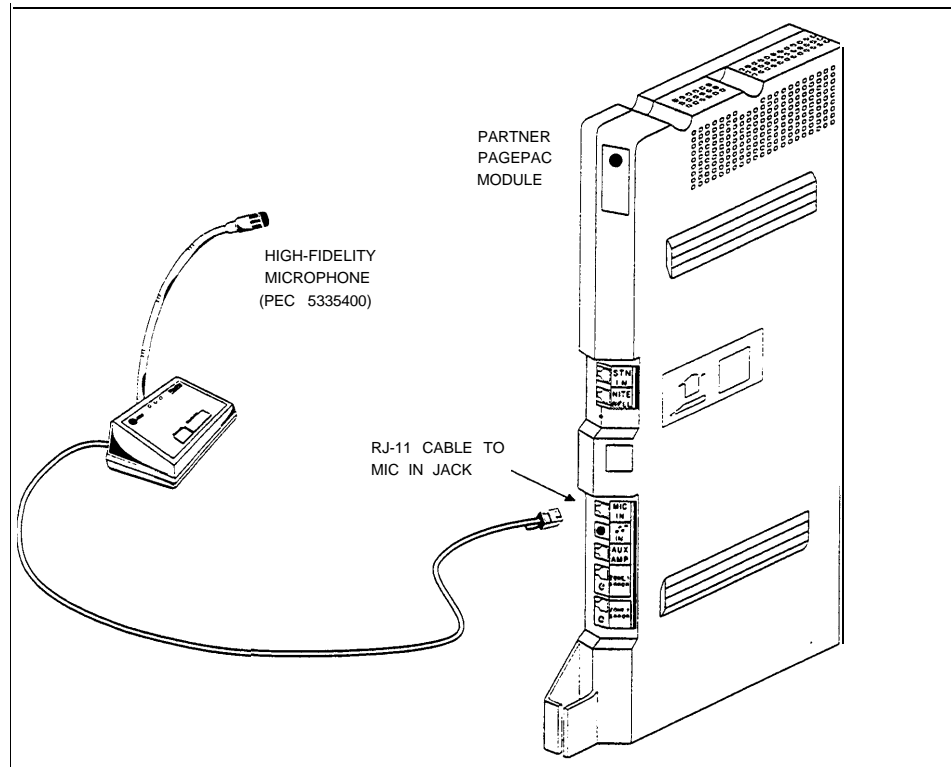

Figure 5-3. Microphone Connections to PARTNER PagePac System

# Night Bell Service

## IMPORTANT: Station Mode Considerations

To ensure full use of "PFT" (Power Failure Transfer) in your PARTNER Plus or PARTNER II phone systems during an emergency or power outage conditions when selecting "Station Mode," these extensions are NOT recommended for use for primary paging areas:

- PARTNER Plus system: Stations 10, 11, 16, 22, 28
- PARTNER II system: Stations 10, 11, 16, 22, 28, 34, 40, 46, 52

*NOTE: Refer to Section 6 Night Bell programming instructions and Section 7 for Operation Information.*

**IMPORTANT:**  
*All lines on the Night Bell extension should be set to "No Ring". (Refer to Sections 6 and 7 for Programming and Operation.)*

*NOTE: Connect RJ-11 cable from PARTNER PagePac module Night Bell port to appropriate station port. (Refer to Sections 6 and 7 for Programming/Operation.)*

The PARTNER PagePac provides a NIGHT BELL port. This RJ-11 jack connects to a station port (Extension) on the PARTNER system that has been configured for night bell service (see Figure 5-4). Once configured, the PARTNER PagePac can detect an incoming ring signal and generate tones over the paging system until the incoming call is terminated or someone answers the call. The Night Bell feature has lower priority than Microphone access, Paging and Doorspeaker, but has a higher priority than background music.

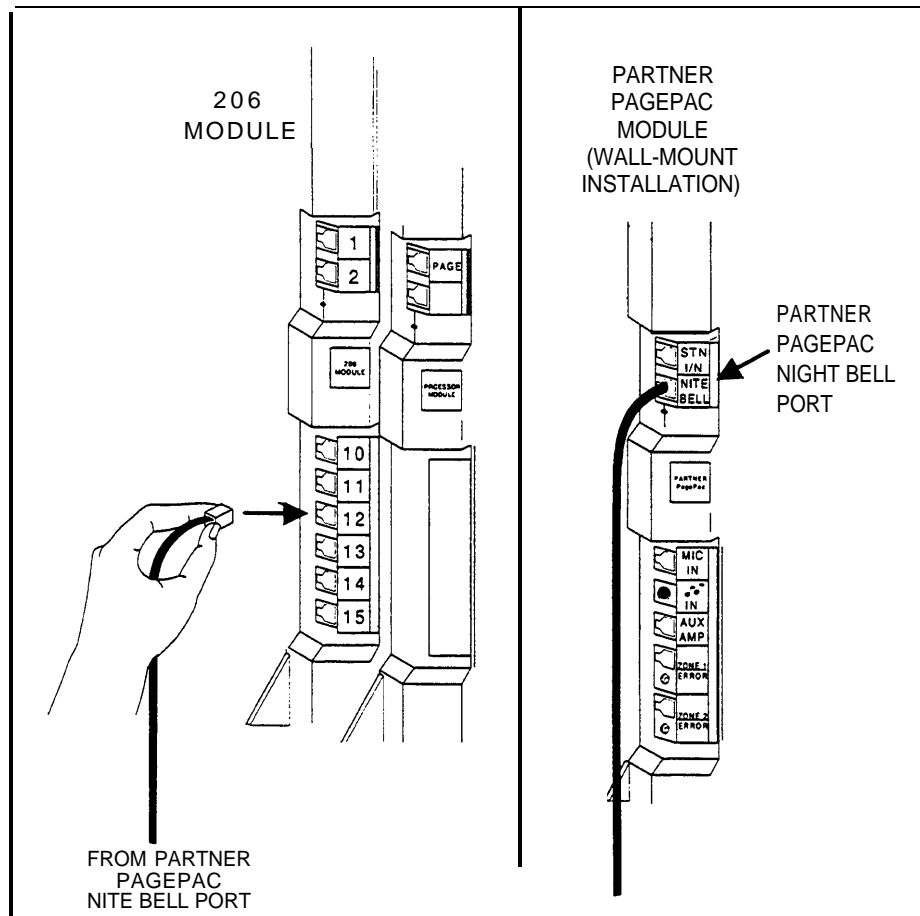

Figure 5-4. Night Bell Service Installation

# 6

---

# Overview

---

After installing the Partner PagePac hardware as described in Sections 2 through 5, you can customize the system to meet the requirements of your business. This chapter describes available programming options and procedures.

## Programming Options

---

There are two types of programming options. System Options affect the overall operation of the system. Zone Options affect the operation of a single zone.

### System Programming Options

---

- **Connect Password** —Requires a user who dials in through the telephone interface to enter the correct password before being permitted to use the system. A special dial tone indicates that the system is waiting for the Connect Password to be entered. This option is disabled by default.
- **Programming Password** —Requires a user who dials in through the telephone interface to enter the correct password when the programming mode is entered. A programming confirmation tone indicates a correctly entered programming password. This option is disabled by default.
- **Door Unlock Code** —Specifies the sequence of digits a user must enter in order to activate the contact closure (door strike plate) for the active door. The default value is 6736 (corresponding to the letters OPEN on the keypad).
- **Pre-Announcement Tone Enabled** —Sends a tone to a zone (and to the user's station, for a telephone page) when the zone is selected. (Available in all zones.) This option is enabled by default. (Automatically turned off when calling a doorspeaker.)
- **Talkback Warning Tone Enabled** —Sends a tone to a zone (and to the user's station, for a telephone page) when the page is selected in talkback mode, advising anyone within range of the zone that conversation is being monitored. (Available in Zones 1 and 2 only.) This option is enabled by default.
- **Confirmation Tone Enabled** —Sends a tone to the user's station (for a telephone page) when a zone is selected. This is ignored if Pre-Announcement Tone or Talkback Warning Tone is enabled (available in all zones). This option is enabled by default.
- **Reset to Factory Defaults** —Causes all System and Zone parameters to revert to their factory default settings. (See Tables 6-1 and 6-2 for factory default settings.)

*Disable this feature if operating in Silent Monitor mode (Dry Loop or Trunk Adapter Mode).*

*If Pre-Announcement Tone is disabled, the Talkback feature must be turned on for the Talkback Warning Tone to be heard.*

---

## Zone Programming Options

---

*Ring Down mode only available in Station Mode.*

*NOTE: Disabling for a doorspeaker zone keeps the zone from being selected as part of a group, but does not prevent it from being selected individually (in Silent Monitor mode—Dry Loop and Station Mode only).*

*Night Bell requires programming the PARTNER Plus/II system for Night Service. See page 6-9.*

*NOTE: The MLC-6 cordless phone (and some standard phones) cannot send continuous DTMF tones.*

*The door sled tone can be sent to any zone, including zone 3.*

- **Type of Zone** —Specifies whether a primary paging zone is to be operated in Page/Speaker, Doorspeaker, or Remote Amplifier mode. The default setting is Page/Speaker. Setting this parameter causes all other options for the zone to be set to the defaults for the specified zone type. (See Table 6-3 for default settings by zone type.)
- **Door Action** —Valid only for a primary paging zone optioned as a Doorspeaker. Specifies the alerting action taken when the Door Bell is pressed: Door Alert or Ring Down. The default setting is Door Alert.
- **Page/Tone Level** —Specifies the volume of pages and tones sent to the primary paging zone. (Available in Zones 1 and 2 only.) Settings range from 0.5 Vrms (Level 1) through 3.4 Vrms (Level 8). Default is 1.9 Vrms (Level 6). (See Tables 6-3 and 6-4.)
- **Music Level** —Specifies the volume of background music sent to a primary paging zone. (Available in Zones 1 and 2 only.) Settings range from 0.5 Vrms (Level 1) through 3.4 Vrms (Level 8). Default is 1.1 Vrms (Level 4). (See Tables 6-3 and 6-4.)
- **Station Page Enabled** —Specifies whether the zone will be selected when the user dials the zone number (or the number of a group that includes the zone) on the telephone keypad. This option is disabled by default for Doorspeaker, enabled otherwise.
- **Music Enabled** —Specifies whether background music will be sent to the zone when paging is not active. (Available in all zones.) This option is disabled by default.
- **Talkback Enabled** —Allows talkback for a primary paging zone. This option is enabled by default for Doorspeaker, disabled otherwise. (Available in Zones 1 and 2 only.) Talkback works only for a single-page zone.
- **Night Bell Enabled** —Sends the night bell tone to the zone when there is activity on the Night Bell input. (Available in all zones.) This option is disabled by default for Doorspeaker, enabled otherwise.
- **Pass DTMF to Zone-** Routes DTMF tones which are entered during a page to the zone without processing. (Available in all zones.) This option is disabled by default.
- **Microphone Page Enabled** —Selects the zone when contact closure of the microphone input is activated. (Available in all zones.) This option is disabled by default for Doorspeaker, enabled otherwise.
- **Door Alert Enabled** —Routes the door alert tone to the zone when the Door Bell is pressed or when Door Ajar is detected. (Available in all zones.) This option is disabled by default for Doorspeaker, enabled otherwise.



Table 6-1 Factory Default Settings—System Options

System Option	Default
Reset to Factory Defaults	—
Connect Password	None
Programming Password	None
Door Unlock Code	6736 (OPEN)
Confirmation Tone Enabled	Yes
Pre-Announcement Tone Enabled	Yes
Talkback Warning Tone Enabled	Yes

Table 6-2 Factory Default Settings—Zone Options

Zone Option	Zones 1 and 2	Zone 3
Type of Zone	Page/Speaker (1)	<i>Not supported</i>
Door Action	<i>Not applicable</i>	<i>Not supported</i>
Page/Tone Level	1.9 Vrms (6)	<i>Not supported</i>
Music Level	1.1 Vrms (4)	<i>Not supported</i>
Station Page Enabled	Yes (1)	Yes (1)
Music Enabled	No (0)	No (0)
Talkback Enabled	No (0)	<i>Not supported</i>
Night Bell Enabled	Yes (1)	Yes (1)
Pass DTMF to Zone	No (0)	No (0)
Microphone Page Enabled	Yes (1)	Yes (1)
Door Alert Enabled	Yes (1)	Yes (1)
1 = DTMF digit 1 is ON (enabled) 0 = DTMF digit 0 is OFF (disabled)		

Table 6-3 Default Settings By Zone Type

Zone Option	Primary Paging Zones (Zones 1 and 2)			Auxiliary Zone (Zone 3)
	Page/Speaker	Doorspeaker	Remote Amp	Aux Amp
Door Action	<i>Not supported</i>	<b>Door Alert</b> (1)	<i>Not supported</i>	<i>Not supported</i>
Page/Tone Level	<b>1.9 Vrms</b> (6)	<b>1.9 Vrms</b> (6)	<b>0.655 Vrms</b> (2)	<i>Not supported</i>
Music Level	<b>1.1 Vrms</b> (4)	<b>1.1 Vrms</b> (4)	<b>0.655 Vrms</b> (2)	<i>Not supported</i>
Station Page Enabled	<b>Yes</b> (1)	<i>Note 1</i>	<b>Yes</b> (1)	<b>Yes</b> (1)
Music Enabled	<b>No</b> (0)	<b>No</b> (0)	<b>No</b> (0)	<b>No</b> (0)
Talkback Enabled	<b>No</b> (0)	<b>Yes</b> (1)	<b>No</b> (0)	<i>Not supported</i>
Night Bell Enabled	<b>Yes</b> (1)	<b>No</b> (0)	<b>Yes</b> (1)	<b>Yes</b> (1)
PassDTMFtoZone	<b>No</b> (0)	<b>No</b> (0)	<b>No</b> (0)	<b>No</b> (0)
Microphone Page Enabled	<b>Yes</b> (1)	<b>No</b> (0)	<b>Yes</b> (1)	<b>Yes</b> (1)
Door Alert Enabled	<b>Yes</b> (1)	<b>No</b> (0)	<b>Yes</b> (1)	<b>Yes</b> (1)

Note 1: Default parameter setting is **No** (0), which causes the zone to be excluded from group pages. (Group pages are discussed in Section 7.) However, a Doorspeaker zone may always be selected in *Silent Monitor* mode by performing a single-zone page (zone number 1 or 2).

## Programming Procedures

To change a factory default setting or a user-programmed setting, you must first access the PARTNER PagePac system.

If you have configured your PARTNER PagePac system:

**For Dry Loop Mode** (connection to Page Port) you will need to dial [INTERCOM] [7] [0].

**For Station Mode** operation, you will need to dial [INTERCOM] , followed by the extension number connected to the PARTNER PagePac paging system. For example, if you have configured the PARTNER PagePac paging system with a cable connecting from the PARTNER PagePac STN I/N port to extension 20 of a PARTNER Plus system module, you would dial [INTERCOM] [2] [0] the first time you wish to access PARTNER PagePac features and programming capabilities.

*If a Connect Password has been enabled, you will hear a special tone. Enter the Connect Password.*

**For Trunk Adapter Mode** you will need to select the trunk which is connected to the PARTNER PagePac unit by pressing the appropriate [LINE] button. For standard telephone access, use *Direct Line Pickup*.

# System Programming Procedure

## To change any system programming option:

1. Access the PARTNER PagePac System (see page 6-5).
2. Dial [\*] [\*] (followed by the programming password, if one has been configured).

*You will hear the special programming mode dial tone.*

NOTE: See "System Programming Options" on page 6-2 for descriptions of the options provided.

3. Dial the appropriate buttons to change or verify an option:

Connect Password	Programming Password	Door Unlock Code	Confirmation Tone Enabled	Pre-Announcement Tone Enables	Talkback Warning Tone Enabled	Reset to Factory Defaults
[3] [0] to change [3] [1] to verify	[3] [2] to change [3] [3] to verify	[3] [4] to change [3] [5] to verify	[4] [0] to change [4] [1] to verify	[4] [2] to change [4] [3] to verify	[4] [4] to change [4] [5] to verify	[1] [0]

If configured correctly, you will hear the Configuration tone (two beeps). (If configured incorrectly, you will hear the Error tone, and will be returned to the *Programming Mode dial tone.*)

4. Dial the appropriate value:

Connect Password	Programming Password	Door Unlock Code	Confirmation Tone Enabled	Pre-Announcement Tone Enabled	Talkback Warning Tone Enabled	Reset to Factory Defaults
Zero to six DTMF digits; terminated by # if fewer than six digits specified	Zero to six DTMF digits; terminated by # if fewer than six digits specified	One to four DTMF digits; terminated by # if fewer than four digits specified	[0] for No [1] for Yes	[0] for No [1] for Yes	[0] for No [1] for Yes	[2] [5] [3] [2] [7] ( C L E A R )

*If dialed correctly, you will hear the Configuration Complete tone (three beeps). (If dialed incorrectly, you will hear the error tone.) You will be returned to the programming dial tone.*

NOTE: The [#] key can be pressed to cancel an uncompleted programming option; you will hear the programming mode dial tone (this does not apply to step 4 for Connect Password, Programming Password, or Door Unlock Code).

5. To terminate the programming mode, press [#].

*You will hear the PARTNER PagePac dial tone.*

# Zone Programming Procedures

## To program Type of Zone, Door Action, Page/Tone Level, or Music Level (Zones 1 and 2 only):

1. Access the PARTNER PagePac System (see page 6-5).
2. Dial [\*] [\*] (followed by the programming password, if one has been configured).

*You will hear the special programming mode dial tone.*

NOTE: See "Zone Programming Options" on page 6-3 for descriptions of the options provided.

3. Dial the appropriate buttons to change or verify an option:

Type of Zone	Door Action	Page/Tone Level	Music Level
[6] [0] to change [6] [1] to verify	[6] [2] to change [6] [3] to verify	[6] [4] to change [6] [5] to verify	[6] [6] to change [6] [7] to verify

*If configured correctly, you will hear the Configuration tone (two beeps). (If configured incorrectly, you will hear the Error tone, and will be returned to the Programming Mode dial tone.)*

4. Dial [1] for zone 1 or [2] for zone 2.

*If dialed correctly, you will hear the Configuration tone again (two beeps.) (If configured incorrectly, you will hear the Error tone, and will be returned to the Programming Mode dial tone.)*

5. Dial the appropriate button to choose an option:

Type of Zone	Door Action	Page/Tone Level	Music Level
[1] for Page/Speaker [2] for Doorspeaker [3] for Remote Amplifier	[1] for Door Alert [2] for Ring Down	[1] through [8] for Amplifier Level (See Table 6-4)	[1] through [8] for Amplifier Level (See Table 6-4)

*If dialed correctly, you will hear the Configuration Complete tone (three beeps). (If dialed incorrectly, you will hear the error tone.) You will be returned to the programming dial tone.*

NOTE: The [#] key can be pressed to cancel an uncompleted programming option; you will hear the programming mode dial tone.

6. To terminate the programming mode, press [#] .

*You will hear the PARTNER PagePac dial tone.*

Table 6-4 Amplifier Levels

Level	Voltage	dBu
1	0.5 Vrms	-3.8
2	0.655 Vrms	-1.5
3	0.86 Vrms	0.9
4	1.1 Vrms	3.0
5	1.4 Vrms	5.1
6	1.9 Vrms	7.8
7	2.5 Vrms	10.2
8	3.4 Vrms	12.7

**To enable or disable Station Page, Music, Talkback, Night Bell, Pass DTMF to Zone, Microphone Page, or Door Alert:**

1. Access the PagePac System (see page 6-5).
2. Dial [\*] [\*] (followed by the programming password, if one has been configured).

*You will hear the special programming mode dial tone.*

NOTE: See "Zone Programming Options" on page 6-3 for descriptions of the options provided.

3. Dial the appropriate buttons to change or verify an option:

Station Page Enabled	Music Enabled	Talkback Enabled	Night Bell Enabled	Pass DTMF to Zone Enabled	Microphone Page Enabled	Door Alert Enabled
[7] [2] to change [7] [3] to verify	[7] [4] to change [7] [5] to verify	[7] [6] to change [7] [7] to verify	[7] [8] to change [7] [9] to verify	[9] [0] to change [9] [1] to verify	[9] [2] to change [9] [3] to verify	[9] [4] to change [9] [5] to verify

*If configured correctly, you will hear the Configuration tone (two beeps). (If configured incorrectly, you will hear the Error tone, and will be returned to the Programming Mode dial tone.)*

4. Dial [1] for zone 1, [2] for zone 2, or [3] for zone 3 (Zones 1 and 2 only for Talkback).

*If dialed correctly, you will hear the Configuration tone again (two beeps.) (If configured incorrectly, you will hear the Error tone, and will be returned to the Programming Mode dial tone.)*

5. Dial [0] to disable; dial [1] to enable.

*If dialed correctly, you will hear the Configuration Complete tone (three beeps). (If dialed incorrectly, you will hear the error tone.) You will be returned to the programming dial tone.*

NOTE: The [#] key can be pressed to cancel an uncompleted programming option; you will hear the programming mode dial tone.

6. To terminate the programming mode, press [#] .

You will hear the PARTNER PagePac dial tone.

## Night Bell

The PARTNER Plus/II system provides a mode of operation called Night Service. By pressing a single button on the system phone at extension 10, the customer can cause incoming after-hours calls to ring on a specified group of extensions.

The PARTNER PagePac module provides additional capabilities to the Night Service feature by allowing Night Bell to ring to one or more paging zones.

## Night Bell Programming Procedure

Refer to your PARTNER Plus/II manual for complete Night Service programming procedures.

1. Make the physical connections for Night Bell service as described in Section 5.
2. Use the PARTNER Plus/II *Line Ringing* feature to set all lines on the Night Bell extension to "No Ring."
3. Using the PARTNER Plus/II *Night Service Group Extensions (#504)* programming feature, place the Night Bell Station into the Night Service group.
4. Use the PARTNER Plus/II *Night Service Button (#503)* procedure to activate the Night Service feature (if not already done) see Figure 6-1.

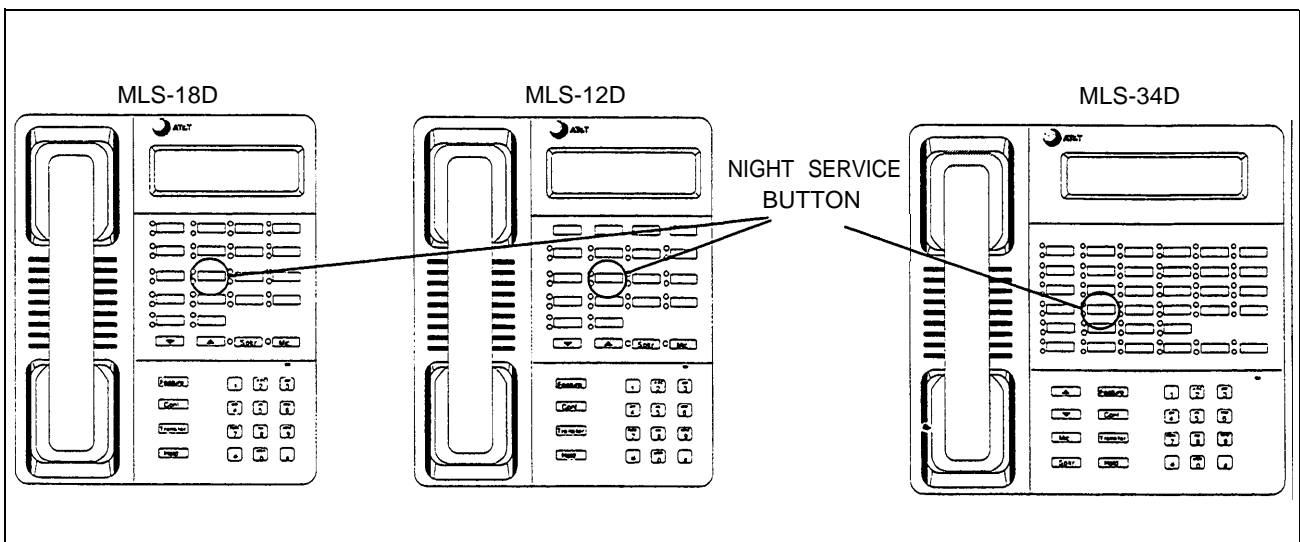

Figure 6-1 Turning Night Bell Service On/Off

# Ring Down

---

*Note: Ring Down mode can only be used when the PARTNER PagePac module is connected to a PARTNER Plus/II station port. Ring Down will not work in Dry Loop or Trunk Adapter Mode.*

The PARTNER PagePac module allows a Doorspeaker Mode zone to be configured in either Door Alert or Ring Down mode. In Door Alert mode, activity on the door is signaled by broadcasting a Door Alert tone over the paging speakers. In Ring Down mode, door activity is signaled by requesting the PARTNER Plus/II switch to dial one or more specified extensions.

## Ring Down Programming Procedure

---

*Refer to your PARTNER Plus/II manual for complete Doorphone programming procedures.*

1. Use PARTNER Plus/II programming procedure #604 or #605 to designate the extension that is connected to the PARTNER Plus/II station interface as a doorphone extension.
2. Use the PARTNER Plus/II *Doorphone Alert Extensions (#606)* procedure to identify up to five extensions that are to be run when the PARTNER PagePac module detects Door Bell or Door Ajar.

### **IMPORTANT: Ring Down Mode Considerations**

If both PagePac zones are configured to be doorspeakers, only one PARTNER doorphone option (#604 or #605) can be programmed, not both. Therefore, if both doorspeakers are used in Ring Down mode, it is not possible to distinguish between the two.

If doorspeakers are to be used and it is necessary to distinguish between the two doorspeakers when they ring, use the PagePac in Door Alert Mode. This way the distinctive rings are available for each doorspeaker.

7

---



# Overview

---

At this point the PARTNER PagePac hardware should be installed as described in Sections 2 through 5. The module should also be programmed with factory default settings or user selections as described in Section 6. You are now ready to use the system. This chapter describes the procedures for operating the PARTNER PagePac system.

## Primary Paging Zones

---

*Refer to Section 6 for programming the type of zone mode, and for descriptions and programming of the various zone options.*

Zones 1 and 2 of the PARTNER PagePac system are called the Primary Paging Zones. Each of these zones can be programmed to operate in Page/Speaker Mode, Doorspeaker Mode, or Remote Amplifier Mode.

## Page/Speaker Mode

---

### Paging Procedure

*A Page/Speaker Mode zone is intended for connection to one or more voice coil speakers.*

*If a Connect Password has been enabled, you will hear a special tone. Enter the Connect Password*

To change a factory default setting or a user-programmed setting, you must first access the PARTNER PagePac system.

1. If you have configured your PARTNER PagePac system:

**For Dry Loop Mode** (connection to Page Port) you will need to dial **[INTERCOM] [7] [0]**.

**For Station Mode** operation, you will need to dial **[INTERCOM]**, followed by the extension number connected to the PARTNER PagePac paging system. For example, if you have configured the PARTNER PagePac paging system with a cable connecting from the PARTNER PagePac STN I/N port to extension 20 of a PARTNER Plus system module, you would dial **[INTERCOM] [2] [0]** the first time you wish to access PARTNER PagePac features and programming capabilities.

**For Trunk Adapter Mode** you will need to select the trunk which is connected to the PARTNER PagePac unit by pressing the appropriate **[LINE]** button. For standard telephone access, use *Direct Line Pickup*.

*You will hear the PARTNER PagePac dial tone in the telephone receiver.*

2. Dial the zone or zone group to which the page is to be made:

<b>[1]</b> — Zone 1	<b>[4]</b> — Zones 2 and 3
<b>[2]</b> — Zone 2	<b>[5]</b> — Zones 1 and 3
<b>[3]</b> — Zone 3	<b>[6]</b> — Zones 1 and 2
	<b>[7]</b> — All Zones

3. Speak into the telephone transmitter to make your page.

During a page, you can dial [#] to go back to the PARTNER PagePac dial tone; dial another zone number or zone group number to switch to that zone or zone group.

4. Hang up the telephone.

## Paging Options

### Pre-Announcement Tone:

If Pre-Announcement Tone is configured, it will be issued before a page to all speakers in the selected zone or group.

### Talkback Mode:

1. Follow steps 1 and 2 of the Paging Procedure, above.  
*In your telephone receiver, you can monitor conversation from the zone enabled for Talkback Mode.*
2. Speak into the telephone transmitter to page, or listen to someone speaking at the zone. (One person can speak at a time; the person speaking into the telephone will take precedence over the person speaking at the zone.)
3. Hang up the telephone.

If Talkback Warning Tone is enabled, a tone will be sent to the zone enabled for talkback, to advise anyone within range of the zone that conversation is being monitored. This tone is also sent to your telephone receiver.

### Microphone Page Enabled:

1. Turn the switch on the microphone to ON.
2. Speak into the microphone to make your page.  
*Your page will be heard at any zone where Microphone Page is enabled.*
3. Turn the microphone switch to OFF.

### Night Bell Enabled:

#### **When Night Service is enabled by the button on the system phone at extension 10:**

1. An outside call comes in.  
*All system phones selected in the Night Service Group will ring. Ringing will be heard at all zones where Night Bell is enabled.*
2. Pick up any telephone on the line that is configured for Night Bell to connect to the incoming call.  
*Night Bell will stop ringing over the paging system.*

*NOTE: Talkback Mode works only for a single-zone page.*

*By default Doorspeaker does not receive a microphone page.*

*Refer to Night Bell Programming in Section 6.*

---

*NOTE: Paging or other higher priority options will override background music. See page 7-7.*

*MLC-6 cordless telephones and certain standard telephones cannot provide continuous DTMF tones.*

#### **Music Enabled:**

If a music source is selected, all zones with Music enabled will play music, as long as other functions are not being used.

#### **Pass DTMF to Zone:**

All touch-tones entered during a page will be routed to any zone with the DTMF to Zone option enabled. If this option is enabled you cannot use the [#] key or select another zone option.

## Doorspeaker Mode

---

A Doorspeaker Mode zone is intended for connection to a single Doorspeaker. Connections can also be made for a door bell, door ajar sensing device, and electronic strike plate control. Doorspeaker mode is available to zones 1 and 2 only.

### Door Bell

*The Door Alert signal is triggered by either a door bell or a door ajar condition.*

*If no answer, Doorspeaker will automatically hang up after 30 seconds.*

#### **Door Alert Mode:**

If the Door Action option has been configured for Door Alert:

1. Someone rings the door bell.  
*At each zone where Door Action is enabled (Zone 1 or 2), you will hear a high-low cadence, sounding once for Zone 1 (Door 1), and twice for Zone 2 (Door 2). This tone repeats every five seconds for half a minute, unless the user answers the door.*  
  
*The first iteration of the Door Alert tone is also played over the speaker of the active door. If no Door Alert tone is heard at the Doorspeaker the PagePac is busy. The user at the door should wait and try again.*
2. Answer the Doorspeaker by dialing into the system. (See step 1 of the Paging Procedure, page 7-2.)  
*If Door Alert is in progress, you will hear a door identification tone in your telephone receiver (one beep for Zone 1 (Door 1), two beeps for Zone 2 (Door 2)), before being connected to the speaker of the active door.*

*The Ring Down is triggered by either a doorbell or a door ajar condition.*

*Station Mode only.*

*If no answer, Doorspeaker will automatically hang up after 30 seconds.*

#### **Ring Down Mode:**

If the Door Action option has been configured for Ring Down:

1. Someone rings the door bell.  
*Refer to Section 6 for programming Doorspeaker Alert Extensions.*  
  
*The Doorspeaker Alert Extensions that have been programmed on the PARTNER switch will ring. The Doorspeaker tone will be heard at the Doorspeaker speaker.*
2. Pick up the ringing extension to answer the door.

---

## Door Ajar

*The Door Alert signal is triggered by either a door bell or a door ajar condition.*

*If you acknowledge the Door Ajar condition, no further alert will occur until the door is closed.*

*The Ring Down is triggered by either a doorbell or a door ajar condition.*

*Refer to Section 6 for programming Doorspeaker Alert Extensions.*

### **Door Alert Mode:**

If the Door Action option has been configured for Door Alert:

1. A door has been opened, but not closed within 30 seconds. A Door Ajar is detected.  
*At each zone where Door Alert is enabled (Zone 1 or 2), you will hear a high-low cadence, sounding once for Zone 1 (Door 1), and twice for Zone 2 (Door 2). This tone repeats every five seconds for half a minute, unless the user acknowledges the Door Ajar condition (or the door is closed).*
2. Dial into the system. (See step 1 of the Paging Procedure, page 7-2.)  
*If Door Ajar is in progress, you will hear a door ajar tone in the telephone receiver (a constant rising and falling tone, or siren).*
3. Acknowledge the Door Ajar condition by entering any touch-tone digit.  
*You will hear a door identification tone (one beep for Zone 1, two beeps for Zone 2) before being connected to the speaker of the active door.*

If you hang up without acknowledging the Door Ajar condition, the alert will be repeated after 30 seconds.

### **Ring Down Mode:**

If the Door Action option has been configured for Ring Down:

1. A door has been opened, but not closed within 30 seconds. A Door Ajar is detected.  
*The Doorspeaker Alert Extensions that have been programmed on the PARTNER switch will ring.*
2. Pick up the ringing extension to answer the door.  
*If Door Ajar is in progress, you will hear a door ajar tone in the telephone receiver (a constant rising and falling tone, or siren).*
3. Acknowledge the Door Ajar condition by entering any touch-tone digit.  
*You will hear a door identification tone (one beep for Zone 1, two beeps for Zone 2) before being connected to the speaker of the active door.*

If you hang up without acknowledging the Door Ajar condition, the ringing will be repeated after 30 seconds.

---

## Door Unlock

*NOTE: Silent Monitor can only be programmed if configured for Dry Loop or Trunk Adapter Mode.*

*The default for this code is*

**[0] [P] [E] [N]** .

Any time you are connected to a door zone—whether in response to a Door Bell or Door Ajar condition, or as a result of paging to a Doorspeaker in Silent Monitor mode (see below)—you may operate the door strike plate if one has been installed:

1. Enter the Door Unlock Code on the phone keypad.  
*The system will activate the control pair on the zone for four seconds, or until it detects that the door has been opened and closed.*

## Silent Monitor

*NOTE: If used in Station Mode, silent monitor will cut off after 2 minutes. (The system hangs up after 30 seconds if no activity is detected.)*

This Doorspeaker feature allows for silent monitoring of a Doorspeaker zone:

1. Make a single-zone page to a Doorspeaker zone: follow steps 1 and 2 from Paging Procedure, page 7-2.  
*The Pre-Announcement Tone will be suppressed. You can monitor conversation at the Doorspeaker zone.*
2. You can speak into the telephone transmitter, or listen to someone speaking at the Doorspeaker zone. (One person can speak at a time; the person speaking into the telephone will take precedence over the person speaking at the Doorspeaker zone.)
3. Hang up the telephone.

---

## Remote Amplifier Mode

*Music/Page levels are adjustable.*

*Door Bell/Door Ajar inputs are ignored (see Figure 3-3).*

This mode is intended for connecting a primary paging zone to a paging amplifier. A Remote Amplifier zone provides the same paging features as a Page/Speaker zone, except that the audio pair has a 0.655 Vrms output (default Level 2), and the system closes the relay on the control pair when presenting a signal (Page, Tone, or Music) on the audio pair, and opens relay contacts when the zone is idle.

---

## Auxiliary Paging Zone

Zone 3 of the PARTNER PagePac system is called the Auxiliary Paging Zone. This zone is intended for connection to a paging amplifier. The audio pair provides a nominal 0 dBm signal to the audio inputs of an amplifier. The Auxiliary Paging Zone operates in the same fashion as a Primary Paging Zone configured in Remote Amplifier Mode, as described above. The main difference is that Zone 3 does NOT provide Talkback or an on-board paging amplifier. The Auxiliary Paging Zone ignores the Door Bell and Door Ajar inputs.

# Input Priorities

---

Each input to the PARTNER PagePac system has its own priority. If more than one input is active at the same time, the signal with the highest priority will take precedence over all the others. In addition, if a higher-priority input becomes active while a lower-priority input is being processed, the PARTNER PagePac system will abandon the lower-priority input in favor of the higher-priority input.

The input priorities, from highest to lowest, are as follows:

- Microphone input
- Station input
- Door input
- Night Bell input
- Music input

## IMPORTANT: Input Priority Considerations

**Door Waiting** —If a user is making a telephone page and someone presses a door button, the PARTNER PagePac module will provide one beep for Door 1 and two beeps for Door 2 in the telephone receiver. The user at the telephone may dial the [#] key (within 15 seconds) to connect to the door and disconnect from current page.

**Microphone/Telephone Page** —If a microphone page is in progress and someone calls in over the telephone interface, the PARTNER PagePac module will generate a busy signal in the telephone receiver.

**Microphone Pages** —A microphone Page has priority over a telephone page. If a telephone page is interrupted by a microphone page, the telephone user will hear eight seconds of busy signal in the receiver, and should hang up.

**Door Alert Tone** —If the PARTNER PagePac module is busy (a higher-priority input is active or another Doorspeaker is in use), a person at a door will not hear the Door Alert tone until the PARTNER PagePac module is no longer busy.

---

# Troubleshooting

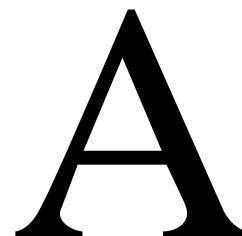

---

## In Case of Difficulty

---

If you have a problem with your system, you may be able to solve it yourself by following the appropriate troubleshooting procedures described in this appendix. If you still need help, In the U. S., AT&T provides a toll-free customer help line 24 hours a day at 1-800-628-2888. For assistance in Canada, contact your local AT&T authorized dealer.

If you call, have the following information ready so that the representatives can better help you:

- The kind of system you have and release number, if present (for example, PARTNER Plus, Release 2).
- In addition to the PARTNER PagePac Module, provide the number of 206 or other expansion modules, and any other information on the labels in the center of the modules.
- The number of line and extensions in your system.

If you followed a troubleshooting procedure and need more help, tell the representative what you did.

---

## Operation During a Power Failure

---

System phones will not work during a power failure—you must use a standard touch-tone or rotary telephone. For more information about setting up your system for a power failure, see Preparing for a Power Failure in Chapter 2 of the PARTNER System manual.

The system maintains settings for approximately 100 hours (four days) after it stops receiving power. After 100 hours without power, all settings return to the factory settings. The PARTNER PagePac Module, however, maintains settings indefinitely.

# Troubleshooting

The charts below and on A-3 describe various problems that can occur, possible causes for each problem, and steps you can take to try to solve the problem yourself.

Table A-1. Troubleshooting Guide

Problem	Corrective Action
<b>Nothing Works</b>	Check power LED Ensure power cord had been attached.
<b>No Sound From One Or More Speakers In Any Zone While Others Work.</b>	Check volume control on problem speaker(s). Check page volume level setting (see Programming Section 6). Check all connections to speakers. Check wire to speakers Replace bad speaker with good one. If speaker cannot be replaced immediately, wire around it to ensure service to the remaining speakers. View Zone Error LEDs while making a page. This could indicate possible short in speaker wiring. <i>NOTE: Look for a mix of voice coil and 70 volt speakers. Replace all 70 volt speakers with voice coil type.</i>
<b>Music Does Not Work, But Paging Does.</b>	Check music volume level setting (see Programming Section 6). Ensure music is turned on for appropriate zones. Adjust volume control on music source. Ensure that the power supply to the music source is plugged in and if an outlet is used, ensure outlet has power. Check music source. Check all connections and wire.
<b>Do Not Hear Page.</b>	Ensure there is power to paging unit. LED is on. Check that zone type is correct. (See Programming Section 6.) Check all connections and wire. Check for correct speakers. The correct speaker should be a voice coil type only. Verify page input with Craft Test Set TS22 or equivalent.



Table A-1. Troubleshooting Guide (continued)

<b>Problem</b>	<b>Corrective Action</b>
<b>No Talkback or Very Low Volume.</b>	Verify talkback is enabled. (See Programming Section 6.)
<b>No Talkback Warning Tone.</b>	Verify Talkback Warning Tone has been enabled.
<b>Door Speaker Dead.</b>	Check all connections and wiring.
<b>Door Ajar Inoperative.</b>	Verify zone is programmed for door operation (see Programming Section 6).
	Check Zone Overload LEDs while paging.
	Ensure correct Doorspeaker type is installed (NO LED on face plate).
	Verify door ajar switch contacts remain open during open door period.
	Check wiring from door switch to PagePac.
<b>Do not Hear Door Attention Tone Over Paging System When Door Phone Button Pressed.</b>	Verify that the "DOOR ACTION" option is set for "DOOR ALERT" for the DoorSpeaker zone, and that "DOOR ALERT" is enabled for the Paging zones. (See Programming Section 6.)
<b>Door Ajar Signals Continuously.</b>	Door ajar switch stuck open or wiring from switch to PagePac module open.
	If door ajar feature not required, verify door ajar pair strapped together.
<b>Door Unlock Code Returns Error Tone.</b>	Incorrect door unlock code entered. Check with system administrator for correct code.
	Door alert not activated.
<b>Unable to Select Zone.</b>	Verify zone is enabled in "STATION PAGE ENABLED" section.
<b>Poor Talkback or Noisy Talkback.</b>	Ensure speaker does not run near bad electrical circuits, fluorescent light fixtures, electric motors, etc.
<b>Paging and Music are Garbled.</b>	Check speaker wire for shorts.
	Look for staples driven through wire.
	Check all connections.
	Ensure that there are not too many speakers on run or zone.

---

## Secondary Circuit Protection

# B

---

### Important Information

---

This equipment is for use on telephone wiring containing a secondary circuit protector. This paging equipment requires a Harris Dracon model 22060-930 **PageGuard®** or **AT&T IROB (PEC 60612) Secondary Circuit Protector where applicable (see Figure B-1)**.

The secondary circuit protector must be located between the primary protector and the paging equipment. Refer to the Important Safety Information and Installation Steps below.

### Important Safety Information

---

- The PageGuard is used when connecting paging equipment directly to telephone lines that may be exposed to high voltage power lines.
- Never install telephone wiring during a lightning storm.
- Never install telephone jacks in wet locations unless the jack is specifically designed for wet locations.
- Never touch uninsulated telephone wires or terminals unless the telephone line has been disconnected at the network interface.
- Use caution when installing or modifying telephone lines.

# Installation Steps

Save these instructions.

1. Install the PageGuard modular plug to the CO telephone lines (see Figure B-2).
2. Connect the green wire on PageGuard to earth ground.
3. Plug a modular connector from the paging equipment telephone line interface to the modular connector on the PageGuard.

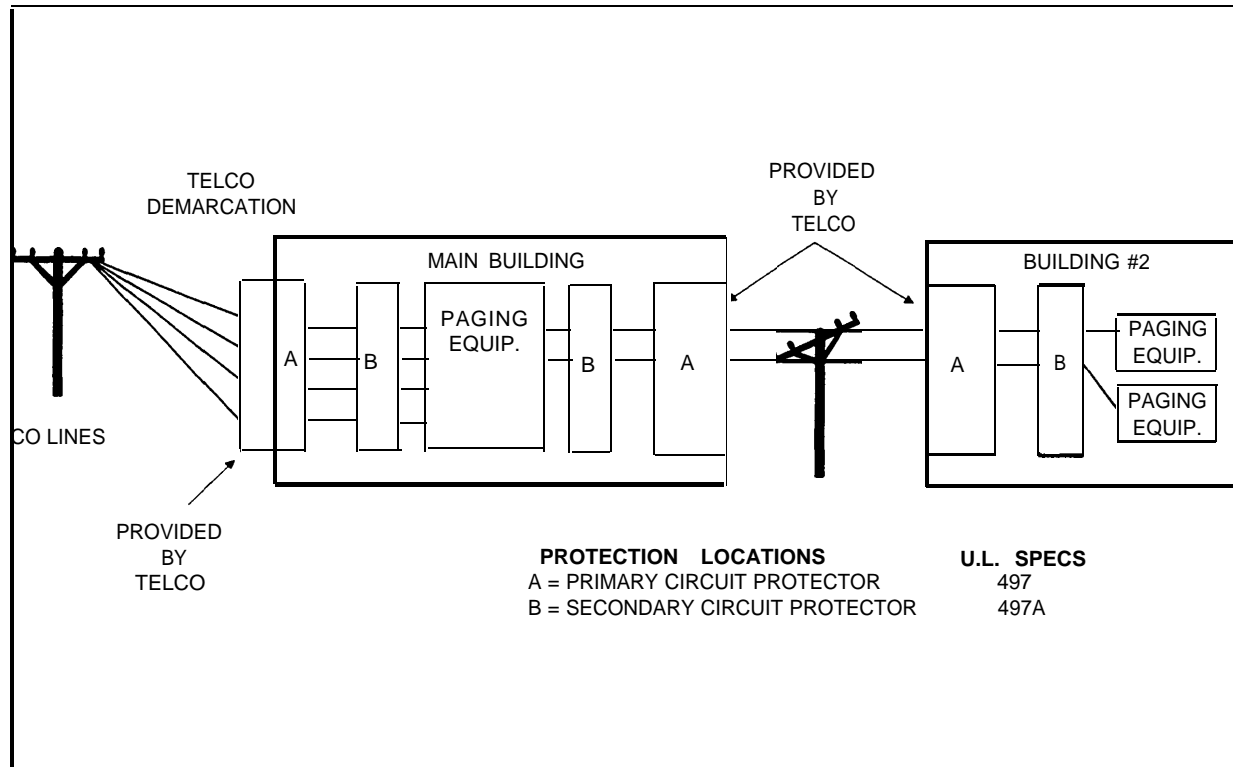

Figure B-1. Example Configurations Requiring Secondary Protection When Paging Equipment is Connected Directly to the Telephone Network.

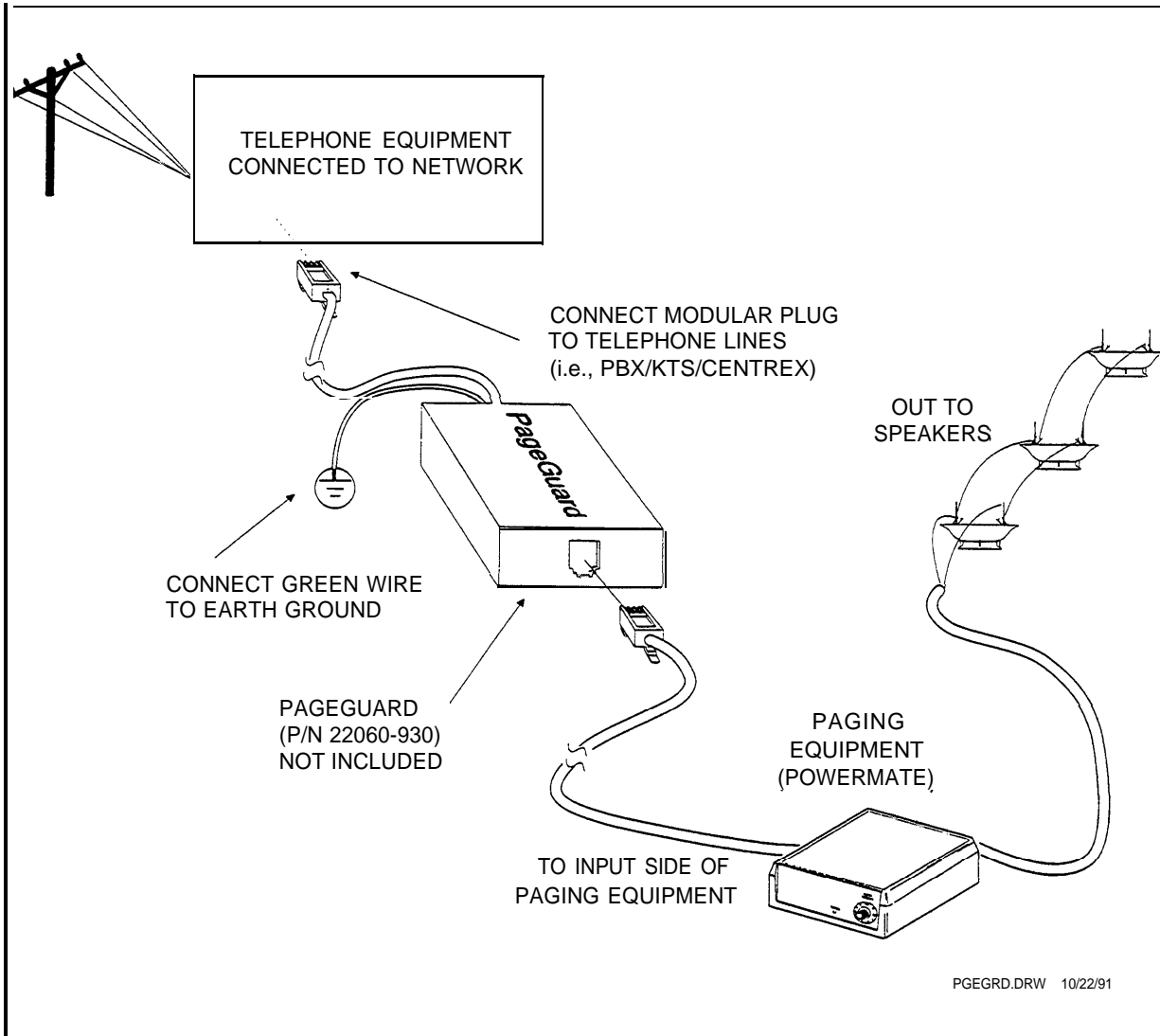
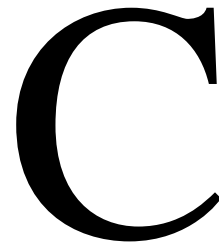

Figure B-2. PageGuard Installation.

---

## FCC and Warranty Information



---

### FCC Statement (Part 68)

---

Component registration for the PARTNER PagePac module has been applied for from the Federal Communications Commission (FCC) in accordance with Part 68 of its Rules. Located on this equipment is a label that contains, among other information, the FCC registration number. If requested, this information must be provided to the telephone company.

Registered equipment may not be used with Coin Telephone Lines. Equipment may be used with Party Lines in areas where state tariffs permit such connections and when equipment is adaptable for such service.

If trouble is experienced, the equipment should be disconnected (unplugged) from the interface to determine if this equipment, the host equipment, or the telephone line is the trouble source. If this equipment is determined to be malfunctioning, it should not be reconnected until repairs are effected.

Connection to host equipment is via a 6-position modular jack (74D Connecting Block). Equivalent connections may be used. This equipment is designated to be installed in a foolproof manner. Permission of the host equipment owner, who may determine the means of connection, is required for connection.

Repairs to this equipment, other than routine repairs, as stated in the Service Manual can be made only by the manufacturer or its authorized agents.

If the equipment causes harm to the telephone network, the local telephone company may temporarily discontinue your service and, if possible, notify you in advance. If advance notice is not practical, you will be notified as soon as possible. You will be given the opportunity to correct the problem and informed of your right to file a complaint with the FCC.

---

The local telephone company may make changes in its facilities, equipment, operations, or procedures that could affect the proper functioning of your equipment. If they do, you will be given adequate notice in writing to allow you an opportunity to maintain uninterrupted telephone service.

## FCC Registration (Part 15)

---

### Radio Frequency Interference

---

The PARTNER PagePac module generates and uses radio frequency energy and if not installed and used in strict accordance with the manufacturer's instructions, may cause interference to radio and television reception. Testing is being conducted for compliance with the limits for a Class A device in accordance with the specifications in Subpart J of Part 15 of the FCC Rules. This testing is designed to provide reasonable protection against such interference. However, there is no guarantee that interference will not occur in a particular installation. If this equipment does cause interference to radio or television reception, which can be determined by turning the Power to the unit off and on, the user is encouraged to try to correct the interference by one or more of the following measures:

- Reorient the radio or TV receiving antenna.
- Relocate the PARTNER PagePac unit with respect to the radio or TV receiver or vice-versa.
- Plug the PARTNER PagePac unit into a different outlet so that it and the radio or TV receiver are on different branch circuits.

If necessary, the user should consult the dealer or an experienced radio/television technician for additional suggestions. The user may find the following booklet, "How To Identify and Resolve Radio-TV Interference Problems," helpful. This booklet was prepared by the Federal Communications Commission (FCC) and is available from the U.S. Government Printing Office, Washington, DC 20402. Stock order No. 004-000-00345-4.

# Warranty Information

## Limited Warranty and Limitation of Liability

AT&T warrants to you that the product will be free from defects in material and workmanship when title passes to you. If you notify AT&T that the product has failed to operate as warranted within one year of the date title passes to you, AT&T will, at its option, repair or replace the component or components of the product that failed to operate as warranted. Any repair or replacement components may be new or refurbished and will be provided on an exchange basis. If AT&T determines that the product cannot be replaced, AT&T will refund the purchase price to you. If you purchased the product directly from AT&T, AT&T will perform warranty repair on your premises in accordance with the terms and conditions of AT&T's "Business Day" or "Around-the-Clock" warranty plans. The details of AT&T's warranty plans may be obtained from AT&T. If you purchased the product from an authorized dealer, you will be covered by AT&T's authorized dealer warranty plan during the warranty period. Contact your authorized dealer for details of AT&T's authorized dealer warranty plan. **AT&T's obligation to repair, replace or refund as set forth above is your exclusive remedy.**

The limited warranties provided above do not cover damages, defects, malfunctions or product failures caused by:

- Failure to follow AT&T's installation, operation or maintenance instructions;
- Unauthorized modification or alteration of the product or its components;
- Product abuse, misuse or the negligent acts of persons not under the reasonable control of AT&T;
- Actions of third parties and acts of God other than power surges (e.g., lightning).

This limited warranty applies only to the product purchased directly from AT&T or purchased directly from an authorized AT&T dealer. This limited warranty does not apply to products purchased or operated outside the United States. You may be required to provide AT&T with proof of purchase before AT&T will perform any warranty repair or provide any warranty replacements.

EXCEPT AS SPECIFICALLY SET FORTH ABOVE, AT&T, ITS AFFILIATES, SUPPLIERS AND DEALERS MAKE NO WARRANTIES, EXPRESS OR IMPLIED, AND SPECIFICALLY DISCLAIM ANY WARRANTY OF MERCHANTABILITY OR FITNESS FOR A PARTICULAR PURPOSE. EXCEPT FOR PERSONAL INJURY, THE LIABILITY OF AT&T, ITS AFFILIATES, SUPPLIERS AND DEALERS FOR ANY CLAIM, LOSS, DAMAGE OR EXPENSE FROM ANY CAUSE WHATSOEVER, REGARDLESS OF THE FORM OF THE ACTION, WHETHER IN CONTRACT, TORT OR OTHERWISE, SHALL NOT EXCEED THE LESSER OF DIRECT DAMAGES PROVEN OR THE REPAIR OR REPLACEMENT COST OF THE SYSTEM OR THE SYSTEM'S PURCHASE PRICE. IN NO EVENT SHALL AT&T, ITS AFFILIATES, SUPPLIERS AND DEALERS BE LIABLE FOR INCIDENTAL, RELIANCE, CONSEQUENTIAL OR ANY OTHER INDIRECT LOSS OR DAMAGE (INCLUDING LOST PROFITS OR REVENUES SUSTAINED OR INCURRED IN CONNECTION WITH THE SYSTEM). THIS LIMITATION OF LIABILITY SHALL SURVIVE FAILURE OF THE EXCLUSIVE REMEDY SET FORTH IN THE LIMITED WARRANTY ABOVE.

### Installation and Maintenance Information

There are several types of installation and maintenance plans available from AT&T and/or your dealer. Please call your AT&T sales representative or authorized dealer for details.

For warranty service, contact your AT&T representative or authorized dealer.

---

# Index

---

## A

AC power	
Connecting to	2-7
AC power cord	2-7
Accessory features	5-1 - 5-5
Amplifier levels	
To change	6-8
Amplifiers	
PagePac amps	1-4
ASCAP	1-2
Audio pair	4-3
Automatic privacy	2-12
Auxiliary amplifier	1-3
Auxiliary amplifier zone	1-2
Auxiliary equipment	1-4
Auxiliary paging zone	7-6

## B

Before you start	2-3
BMI	1-2
Bracket	2-5
Wall mount template	2-9

## C

C.O. lines	2-12
C.O. telephone lines	B-2
Cable connections	2-11
Configuration complete tone	6-7
Configuration information	2-4
Configuration tone	6-6
Confirmation tone enabled	6-2, 6-4
To change	6-6
Connect password	6-2, 6-4
To change	6-6
Connection block wiring	
Diagram	3-6
Connection blocks	4-3
Contact closure	5-4

## D

Default settings	
By zone type	6-5
Difficulty	A-1
Direct line pickup	2-12, 2-15
Door action	6-3 - 6-4, 7-5
Door action programming	
To change	6-7
Door ajar	4-2, 7-5
Pair wires	4-3
Door alert enabled	6-3 - 6-4
To change	6-8
Door alert mode	4-2, 7-4
Door alert tone	7-4
Input priority	7-7
Door bell	7-4
Door control	1-2
Door input	
Input priority	7-7
Priority level	2-15
Door unlock code	6-2, 6-4, 7-6
To change	6-6
Door waiting	
Input priority	7-7
Doorspeaker alert extensions	7-5
Doorspeaker	1-4 - 1-5, 4-2, 4-6, 7-4, 7-6
Diagram	4-2
Doorspeaker	
Installation diagram	4-3
Doorspeaker button	4-2
Doorspeaker mode	3-2, 4-5
Operating procedures	7-4
Dry loop	
Considerations	2-12
Dry loop mode	2-11, 4-2
Programming	6-5

## E

Electronic strikeplate	4-2
Error LEDs	1-3
Error tone	6-7



Extension port	2-11	Interface mode	
External music source		Cable connections	2-11
Connections diagram	5-2	Dry loop/station/ and trunk adapter modes	2-11
<b>F</b>		Selecting	2-11
Factory default settings		Station mode	2-11
Connect password	6-4	Trunk adapter mode	2-11
Door unlock code	6-4	IROB	B-1
Pre-announcement tone enabled	6-4	<b>L</b>	
Programming password	6-4	Limited warranty	
Reset	6-4	Limitation of liability	C-3
Talkback warning tone enabled	6-4	Line ringing	
Zone options	6-4	Night bell service	6-9
FCC and warranty information	C-1 - C-3	<b>M</b>	
FCC information	ii	Microphone	1-4
FCC registration		Access for paging	5-4
Part 15	C-2	Input priority	7-7
FCC statement		Microphone attendant access	1-2
Part 68	C-1	Microphone connections	
Features	1-3	Diagram	5-4
Features and capabilities	1-2	Microphone input	1-3
Feedback form	vi	Priority level	2-15
<b>G</b>		Microphone page	7-3
Green LED	2-7	Microphone Page enabled	6-3 - 6-4
Group extensions		To change	6-8
Night bell service	6-9	Telephone page	
<b>H</b>		Input priority	7-7
Hands free	3-2	Module components	1-3
Help line	ii, A-1	Modules	
How to comment on this guide	vi	Available	2-4
Feedback Form	vi	Mounting	
How to use this guide	v	Flat onto wall	2-6
<b>I</b>		Onto table or desk	2-6
Important safety instructions	2-2	Music enabled	6-3 - 6-4, 7-4
Input / outputs	1-3	To change	6-8
Input priorities	2-15, 7-7	Music input	1-2 - 1-3
Considerations	7-7	Input priority	7-7
Installation	2-1 - 2-7, 2-9, 2-11 - 2-15	Priority level	2-15
Clearance	2-6	Music level	6-3 - 6-4
Interface mode connections	2-13	Background	5-3
Module	2-4	<b>N</b>	
Page/Speaker mode	3-1 - 3-8	Network interface	1-1
Trunk adapter mode	2-14	Night bell	1-2
Installing a music source	5-2	Appropriate station port	5-5
Interface connections	2-13	Extension	5-5

Port	5-5	Diagram	3-3
Programming procedures	6-9	PARTNER PagePac module	
Night bell		Features	1-3
Installation diagram	5-5	Installation	2-4
Service	5-5	Mounting bracket	2-5
Night bell enabled	6-3 - 6-4	PARTNER PagePac Trunk Adapter	2-14
To change	6-8	PARTNER Plus	1-2, 2-2
		PARTNER Plus system	5-5
Night bell input		PARTNER system phone	2-3
Input priority	7-7	PARTNER II system	5-5
Priority level	2-15	Pass DTMF to zone	6-3 - 6-4, 7-4
Night bell service	1-3, 7-3	Pass DTMF to zones enabled	
On/off	6-9	To change	6-8
Night service button		PFT (power failure transfer)	2-12
Diagram	6-9	Phone system	
<b>O</b>		Configured	2-4
103A connection block		Power failure	
Diagram	4-3	Operating during	A-1
Operating procedures	7-1 - 7-7	Power failure transfer	5-5
Ordering information	ii, 1-4	Power supply	2-14
Overview	1-1 - 1-5	Pre-announcement tone	7-6
<b>P</b>		Enabled	6-2, 6-4
Page port	2-11, 2-13	To change	6-6
Page/speaker mode		Primary paging zones	1-2
operating procedures	7-2	Operating procedures	7-2
Page/tone level	6-3 - 6-4	Zones 1 and 2	3-2
Page/tone level programming		Product safety labels	vi
To change	6-7	Programming	6-1 - 6-10
PageGuard	B-1	Overview	6-2
Installation	B-2	Programming mode dial tone	6-6, 6-7
Pages		Programming options	6-2
Limited to	2-12	Programming password	6-2, 6-4, 6-7
Paging access	3-2	To change	6-6
Paging procedures		Programming procedures	
Dry loop, station, and trunk		For dry loop, station, and trunk	
adapter mode	7-2	adapter mode	6-5
PARTNER carrier		<b>Q</b>	
Open slot	2-4	Quick test	
PARTNER communications system		Doorspeaker equipment	4-5
Plus/II	2-4, 2-12	Dry loop mode	4-5
PARTNER II	1-2, 2-2	Paging to loudspeakers	3-7
PARTNER PagePac		Station mode	4-5
Maintaining settings	A-1	Trunk adapter mode	4-5
Mounting flat onto wall	2-6	<b>R</b>	
Mounting onto desk or table	2-6	Radio frequency interference	C-2
PARTNER PagePac connections		Reference materials	vi

Ordering	vi	Change options	6-6
Remote amplifier mode	3-2, 7-6	System phones	8-1
Remote doorspeaker		<b>T</b>	
Diagram	4-4	Talkback enabled	6-4
Remote volume adjust	1-2	Talkback	1-2, 6-2
Reset to factory defaults	6-2, 6-6	Capabilities	3-2
Ring down mode	6-3, 7-4 - 7-5	Talkback enabled	6-3
Programming procedure	6-10	To change	6-8
Ring down mode considerations	6-10	Talkback mode	7-3
Ringdown mode	4-2	Talkback warning tone	
<b>S</b>		Enabled	6-2
Safety Instructions		Talkback warning tone enabled	6-4
Installation personnel	2-2	To change	6-6
Secondary circuit protection	1-1 - 1-3	Telephone access	1-2, 2-15
Shipping carton contents	2-3	Dry loop/station /and trunk	
Diagram	2-3	adapter modes	2-15
Silent monitor	7-6	Telephone lines	B-1
Silent monitor mode	6-2 - 6-3	Telephones	
66-type block	4-3	PARTNER system and standard	
Speaker run methods		touch-tone	2-3
Diagram	3-5	Template	
Speaker/page mode installation	3-1 - 3-8	Wall mount	2-9
Speakers	3-2	Touch-tone phone	
Voice coil	1-4	Use during power failure	8-1
Specifications	1-5	Trademarks	ii
Specifications		Troubleshooting	A-1 - A-3
Dimensions and weight	1-5	Troubleshooting guide	A-2
Environmental	1-5	Trunk adapter	1-2, 2-14, 4-2
Phone company information	1-5	Trunk adapter mode	2-11
Standard touch-tone phone	2-3	Connections	2-14
Station input		Considerations	2-12
Input priority	7-7	Programming	6-5
Priority level	2-15	Trunk port	2-13
Station interface	1-3	Type of zone	6-3
Station mode	2-11, 4-2, 6-3	Type of zone programming	
Considerations	2-12	To change	6-7
Programming	6-5	<b>V</b>	
Station page enabled	6-3 - 6-4	Voice coil speakers	1-4, 3-2
To change	6-8	Volume adjustment	
Station port	2-13	Page/music	5-3
STN I/N port	2-11, 2-13, 2-15	Volume level	
Connections	2-14	Diagram	5-3
Support telephone numbers		<b>W</b>	
Helpline	ii	Wall mount template	2-9
System options	6-2	Warranty	
System programming options	6-2		
System programming procedure			

---

Installation and Maintenance	C-3
Warranty information	C-3
Wiring	2-2

## **Z**

Zone	
Type	6-4
Zone 1 and zone 2	1-3
Zone options	6-2
Zone overload warning	1-2
Zone programming options	6-3
Zone programming procedure	6-7

Copyright 1993 AT&T  
All Rights Reserved  
Printed in U.S.A.

Comcode 406980722  
518-455-016  
0117225615-001  
Issue 2, May 1993  
Graphics © AT&T 1988

