



Avaya 1140E IP Deskphone with SIP Software – User Guide

IP Office 8.0

Document Status: **Standard**

Document Version: **02.03**

Document Number: **AV40050-105**

Date: **November 2011**



© 2010 Avaya Inc. All Rights Reserved.

Notices

While reasonable efforts have been made to ensure that the information in this document is complete and accurate at the time of printing, Avaya assumes no liability for any errors. Avaya reserves the right to make changes and corrections to the information in this document without the obligation to notify any person or organization of such changes.

Documentation disclaimer

Avaya shall not be responsible for any modifications, additions, or deletions to the original published version of this documentation unless such modifications, additions, or deletions were performed by Avaya. End User agree to indemnify and hold harmless Avaya, Avaya's agents, servants and employees against all claims, lawsuits, demands and judgments arising out of, or in connection with, subsequent modifications, additions or deletions to this documentation, to the extent made by End User.

Link disclaimer

Avaya is not responsible for the contents or reliability of any linked Web sites referenced within this site or documentation(s) provided by Avaya. Avaya is not responsible for the accuracy of any information, statement or content provided on these sites and does not necessarily endorse the products, services, or information described or offered within them. Avaya does not guarantee that these links will work all the time and has no control over the availability of the linked pages.

Warranty

Avaya provides a limited warranty on this product. Refer to your sales agreement to establish the terms of the limited warranty. In addition, Avaya's standard warranty language, as well as information regarding support for this product, while under warranty, is available to Avaya customers and other parties through the Avaya Support Web site: <http://www.avaya.com/support>

Please note that if you acquired the product from an authorized reseller, the warranty is provided to you by said reseller and not by Avaya.

Licenses

THE SOFTWARE LICENSE TERMS AVAILABLE ON THE AVAYA WEBSITE, [HTTP://SUPPORT.AVAYA.COM/LICENSEINFO](http://support.avaya.com/LICENSEINFO) ARE APPLICABLE TO ANYONE WHO DOWNLOADS, USES AND/OR INSTALLS AVAYA SOFTWARE, PURCHASED FROM AVAYA INC., ANY AVAYA AFFILIATE, OR AN AUTHORIZED AVAYA RESELLER (AS APPLICABLE) UNDER A COMMERCIAL AGREEMENT WITH AVAYA OR AN AUTHORIZED AVAYA RESELLER. UNLESS OTHERWISE AGREED TO BY AVAYA IN WRITING, AVAYA DOES NOT EXTEND THIS LICENSE IF THE SOFTWARE WAS OBTAINED FROM ANYONE OTHER THAN AVAYA, AN AVAYA AFFILIATE OR AN AVAYA AUTHORIZED RESELLER, AND AVAYA RESERVES THE RIGHT TO TAKE LEGAL ACTION AGAINST YOU AND ANYONE ELSE USING OR SELLING THE SOFTWARE WITHOUT A LICENSE. BY INSTALLING, DOWNLOADING OR USING THE SOFTWARE, OR AUTHORIZING OTHERS TO DO SO, YOU, ON BEHALF OF YOURSELF AND THE ENTITY FOR WHOM YOU ARE INSTALLING, DOWNLOADING OR USING THE SOFTWARE (HEREINAFTER REFERRED TO INTERCHANGEABLY AS "YOU" AND "END USER"), AGREE TO THESE TERMS AND CONDITIONS AND CREATE A BINDING CONTRACT BETWEEN YOU AND AVAYA INC. OR THE APPLICABLE AVAYA AFFILIATE ("AVAYA").

Copyright

Except where expressly stated otherwise, no use should be made of the Documentation(s) and Product(s) provided by Avaya. All content in this documentation(s) and the product(s) provided by Avaya including the selection, arrangement and design of the content is owned either by Avaya or its licensors and is protected by copyright and other intellectual property laws including the sui generis rights relating to the protection of databases. You may not modify, copy, reproduce, republish, upload, post, transmit or distribute in any way any content, in whole or in part, including any code and software. Unauthorized reproduction, transmission, dissemination, storage, and or use without the express written consent of Avaya can be a criminal, as well as a civil offense under the applicable law.

Third Party Components

Certain software programs or portions thereof included in the Product may contain software distributed under third party agreements ("Third Party Components"), which may contain terms that expand or limit rights to use certain portions of the Product ("Third Party Terms"). Information regarding distributed Linux OS source code (for those Products that have distributed the Linux OS source code), and identifying the copyright holders of the Third Party Components and the Third Party Terms that apply to them is available on the Avaya Support Web site: <http://support.avaya.com/Copyright>.

Trademarks

The trademarks, logos and service marks ("Marks") displayed in this site, the documentation(s) and product(s) provided by Avaya are the registered or unregistered Marks of Avaya, its affiliates, or other third parties. Users are not permitted to use such Marks without prior written consent from Avaya or such third party which may own the Mark. Nothing contained in this site, the documentation(s) and product(s) should be construed as granting, by implication, estoppel, or otherwise, any license or right in and to the Marks without the express written permission of Avaya or the applicable third party. Avaya is a registered trademark of Avaya Inc. All non-Avaya trademarks are the property of their respective owners.

Downloading documents

For the most current versions of documentation, see the Avaya Support. Web site: <http://www.avaya.com/support>

Contact Avaya Support

Avaya provides a telephone number for you to use to report problems or to ask questions about your product. The support telephone number is 1-800-242-2121 in the United States. For additional support telephone numbers, see the Avaya Web site: <http://www.avaya.com/support>

Contents

| | |
|---|-----------|
| Welcome | 11 |
| Basic features | 11 |
| IP Deskphone controls | 14 |
| Avaya 1140E IP Deskphone display | 20 |
| Cleaning the IP Deskphone LCD display screen | 21 |
| Context-sensitive soft keys | 22 |
| Idle display screen after dial pad input | 27 |
| In-call context-sensitive soft keys | 29 |
| Navigation keys | 37 |
| Using a USB Mouse | 39 |
| Available Avaya 1140E IP Deskphone call features | 40 |
| Security features | 40 |
| Secure connection | 41 |
| Regulatory and safety information | 42 |
| Other | 45 |
| DenAn regulatory notice for Japan | 45 |
| Getting Started | 46 |
| Before you begin | 47 |
| Connecting the components | 47 |
| Removing the stand cover | 49 |
| Connecting the AC power adapter (optional) | 50 |
| Connecting the handset | 51 |
| Connecting the headset (optional) | 52 |
| Selecting the headset tuning parameter | 52 |
| Connecting the LAN ethernet cable | 53 |
| Installing additional cables | 54 |

- Wall-mounting the IP Deskphone (optional) 54
- Entering text 57
- Entering text using the IP Deskphone dialpad 58
- Configuring the dialpad to alphanumeric dialing 61
- Entering text using the USB keyboard 62
- Accessing the IP Deskphone 64**
- Logging on for the first time 64
 - Automatic login 64
 - Configuring the domain 65
 - Password protection for domains 66
 - Selecting a language 67
 - Logging on to your Avaya 1140E IP Deskphone 68
 - Configuring the duration of the login 72
- Timed logoff 73
 - Timed logoff while IP Deskphone is idle 73
 - Timed logoff while on a call 73
 - Selecting a location 74
- User Profile 75
- Confirmation logon screen 75
- Logging off from the IP Deskphone 76
- Logging on and off from a different extension 77
- Making an emergency call 79
- Configuring the Avaya 1140E IP Deskphone 81**
- Adjusting the display screen contrast 81
- Creating the idle screen text display 82
- Configuring the Backlight Screensaver 83
- Configuring Menu Auto back-out 84
- Selecting a ring pattern 86
- Adjusting the volume 87
 - Adjusting the ring volume 87

| | |
|--|------------|
| Adjusting the volume of the Handset, headset, and Handsfree mode | 89 |
| Selecting a language | 92 |
| Selecting the date and time format | 93 |
| USB headset | 97 |
| Headset menu | 98 |
| Presence of USB headset | 102 |
| Audio format selection | 103 |
| Generic USB headset | 104 |
| Avaya USB headset adapter with HID | 105 |
| Third-party USB headsets with HID | 109 |
| Analog Terminator Adapter for analog (500/2500-type) telephone or fax machine | 114 |
| Configuring Bluetooth wireless technology headset | 117 |
| Making a call | 128 |
| Making a call using off-hook dialing | 129 |
| Making a call using on-hook dialing | 131 |
| Using handsfree calling | 131 |
| Making a call using redial | 133 |
| Making an intercom call | 134 |
| Making paging calls | 135 |
| Making a call using automatic callback | 136 |
| Joining a conference call | 137 |
| Receiving a call | 139 |
| Caller identification | 139 |
| Answering an incoming call | 140 |
| Ignoring an incoming call | 141 |
| Configuring Do Not Disturb | 142 |
| Setting an interval for after-call work | 143 |

| | |
|--|------------|
| Receiving intercom calls | 145 |
| Receiving calls to a pickup group | 145 |
| Receiving paging calls | 147 |
| Receiving voice mail | 148 |
| Enabling or disabling voice mail | 148 |
| Retrieving voice mail | 149 |
| Forwarding calls to another number | 150 |
| Call forwarding | 150 |
| Follow me | 155 |
| The Address Book | 159 |
| Viewing the Address Book | 159 |
| Initiating a call from the Address Book | 160 |
| Adding a contact to your Address Book | 162 |
| Editing a contact in your Address Book | 163 |
| Copying information to the Address Book | 167 |
| Searching for a contact in the Address Book | 169 |
| Using the Search feature in the Address Book | 170 |
| Using the Search feature | 171 |
| Using Local Search | 171 |
| Call Inbox | 174 |
| Accessing the Call Inbox | 174 |
| Managing calls in the Call Inbox while not on a call | 174 |
| Viewing the details of a call in the Call Inbox | 177 |
| Managing missed calls | 178 |
| Missed Calls Notification | 179 |
| Initiating a call from the Call Inbox | 181 |
| Deleting calls in your Call Inbox | 183 |
| Accessing the calls in your Call Inbox during a call | 183 |

| | |
|--|------------|
| Call Outbox | 185 |
| Accessing the Call Outbox | 186 |
| Managing calls in the Call Outbox while not on a call . . | 186 |
| Initiating a call from the Call Outbox | 187 |
| Deleting calls from your Call Outbox | 188 |
| Viewing the details of a call in the Call Outbox | 189 |
| Accessing the calls in your Call Outbox during a call . . . | 190 |
| | |
| While on an active call | 192 |
| Making a new call | 192 |
| Initiating a call using the active call context-sensitive soft key menu | 193 |
| Call Waiting | 193 |
| Placing a call On Hold | 194 |
| Multiple calls On Hold | 194 |
| Using call conferencing | 201 |
| Transferring a call | 202 |
| Using the Call Park feature | 205 |
| Retrieving a Parked Call | 206 |
| Using account codes | 207 |
| Recording a call | 208 |
| | |
| Configuring custom settings | 210 |
| Programmable keys | 210 |
| Assigning features to programmable keys | 212 |
| Erasing a programmable key | 213 |
| Restoring the default settings for programmable keys | 214 |
| Configuring speed dial keys | 215 |
| Querying programmable keys | 216 |
| Using the relay option | 217 |
| Twinning | 220 |

| | |
|---|------------|
| Configuring Privacy settings | 221 |
| Incoming call privacy | 222 |
| Outgoing call privacy | 223 |
| Audio Codecs | 223 |
| Audio Codec Selection | 224 |
| Audio Codec Ordering | 224 |
| Automatic remote firmware updates | 225 |
| Screensaver/screen lock | 225 |
| Background image | 230 |
| Selecting an image screen | 230 |
| USB flash memory device support | 230 |
| Notes on File Manager | 234 |
| Maintaining the IP Deskphone | 237 |
| Viewing the IP Deskphone information | 237 |
| Viewing additional phone information | 237 |
| Accessing the services menu | 239 |
| Checking for updates | 239 |
| Resetting the IP Deskphone | 240 |
| Erasing the user data | 242 |
| Network menu | 247 |
| Visual indicators | 249 |
| Display screen icons | 249 |
| Visual Alerter/Message Waiting Indicators | 250 |
| Monitoring other extensions | 251 |
| Quick reference | 253 |
| Fixed keys | 253 |
| Commonly used functions | 255 |
| Context-sensitive soft keys | 257 |
| Display screen icons | 260 |

| | |
|--|------------|
| Limitations | 263 |
| Third party terms | 265 |
| Third Party Terms for Avaya 11xx 12xx sw release 3.x thru 4.x . 265 | |
| GNU | 266 |
| Zlib | 273 |
| Libpng | 273 |
| Kern_random | 276 |
| Wchar functions | 277 |
| Libjpeg | 278 |
| T-Rex | 279 |

Welcome

Your Avaya 1140E IP Deskphone brings voice and data to your desktop. The IP Deskphone connects directly to a Local Area Network (LAN) through an Ethernet connection. You can upgrade the software on your IP Deskphone to communicate using Session Initiation Protocol (SIP).

In this guide, the labels for programmable keys appear beside the keys and labels for context-sensitive soft keys appear directly above the keys. [Figure 1](#) shows the user-defined feature keys and context-sensitive soft keys.

Figure 1: Programmable keys and context-sensitive soft keys

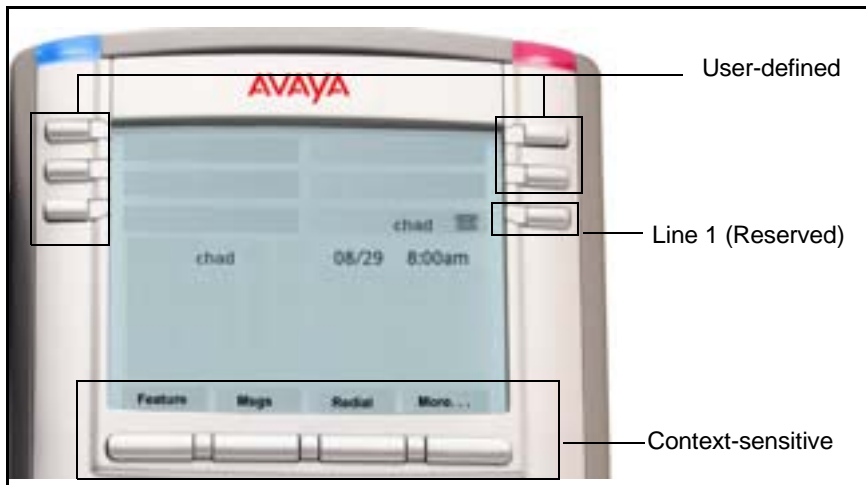

Basic features

Your Avaya 1140E IP Deskphone supports the following features:

- five programmable keys with labels and indicators
- one reserved line key
- four context-sensitive soft keys
- graphical, high-resolution LCD display, backlit, with adjustable contrast

- high-quality speaker IP Deskphone
- volume control keys for adjusting the ringer, speaker, handset, and headset volume
- six specialized feature keys:
 - Quit
 - Directory
 - Inbox
 - Outbox
 - Services
 - Copy
- six call-processing fixed keys:
 - Mute
 - Handsfree
 - Goodbye
 - Expand
 - Headset
 - Hold
- gigabit Ethernet ports
- built-in gigabit Ethernet switch for shared PC access
- headset jack with an On/Off key
- USB port to support a keyboard or mouse

Note: Powered downstream 1.1-compliant USB hubs are supported, including USB 2.0 hubs, if they offer USB 1.1 backwards compliancy.
- automatic Dynamic Host Configuration Protocol (DHCP) network configuration
- hearing aid compatibility
- wireless headset support using a Bluetooth® 1.2 wireless technology compliant Audio Gateway (headset Profile, Bluetooth Power Class 2).
- intercom/paging support



- secure digits when accessing voice mail during a call
- logging off the IP Deskphone without entering a password
- dialing a call from the Inbox
- the capacity to attach up to three Expansion Modules for IP Deskphones 1100 Series, adding up to 54 programmable keys

IP Deskphone controls

Figure 2 shows the Avaya 1140E IP Deskphone.

Figure 2: Avaya 1140E IP Deskphone



This section describes the controls on your IP Deskphone. Your IP Deskphone can have fixed keys with icons or with labels. This document presents both versions of the fixed key.



The keys on either side of the LCD display area are **User-defined feature keys**, with labels on the LCD. The system administrator can reserve some keys for specific functions during tasks and for advanced configuration.

You can define these keys for specific functions, such as Call Forward.

Note: The key on the lower right is reserved as your default line key.



Context-sensitive soft keys are located below the display area. The LCD label above each key changes based on the active feature.

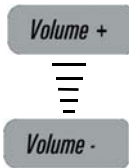

Use the **Volume control** buttons to adjust the volume of the ringer, handset, headset, speaker, and the Handsfree feature. Press the top button to increase the volume, and press the bottom button to decrease the volume.



Press the **Mute** key to listen to the call without transmitting. Press the **Mute** key again to return to two-way conversation. The **Mute** key applies to handsfree, handset, and headset microphones.

Note: When you enable mute, a red LED on the **Mute** key remains lit.



Press the **Handsfree** key to activate the built-in speaker and microphone of the IP Deskphone.

Note: The Handsfree LED indicator on the **Handsfree** key lights to indicate when handsfree is active.



Use the **Navigation Key Cluster** to scroll through menus and lists that appear on the LCD display screen or for text entry. The outer part of this key cluster rocks for up, down, left, and right movements. For more information, see “[Navigation keys](#)” on [page 37](#).



Use the **Enter** key, at the center of the **Navigation Key Cluster**, to select menu items or to confirm changes.

Note: The **Enter** key has the same function as the context-sensitive soft keys **Select** and **Set**.



Press the **Goodbye/Release** key to terminate an active call. When multiple calls are active, press the **Goodbye/Release key** to end the highlighted call.

Use the **Goodbye/Release** to close menu navigation or cancel user tasks.



Headset |

Press the **Headset** key to answer a call using the headset or to switch a call from the handset or handsfree to the headset.

Note: The headset LED indicator on the **Headset** key lights to indicate that the headset is in use.



Hold

Press the **Hold** key to put an active call on hold. Press the **Hold** fixed key to return to a call on hold.

You can have several calls in a hold state.



Use the **Dialpad** to enter numbers and text.

To navigate to an item in a menu, press the corresponding number on the dialpad to activate the item or continue navigate the list of items.



When you receive a voice message, the red **Visual Alerter/Message Waiting Indicator** lights. Also, when the ringer sounds, this indicator flashes.



Copy

Press the **Copy** key to copy contact information from one source such as the Address Book to a destination such as a feature key.



Services

Press the **Services** key to access the following features:

1. Search—search in the local directory (personal Address Book) and the global directory (network Address Book for names and phone numbers)
2. Login—log in to your IP Deskphone.
3. Logout—log out of your IP Deskphone.
4. Check For Updates—check for the latest software update for the IP Deskphone.
5. Reset Phone—reset your IP Deskphone.
6. File Manager—manage the IP Deskphone file system and USB Devices attached to the IP Deskphone.
7. Logging System—enable or disable the logging process.
8. Phone Information—view information about the hardware and software on your IP Deskphone, including user information.

Press the **Services** key twice quickly to access the Network menu.



Quit

Press the **Quit** key to cancel the current operation or to exit the menu.

Note: Pressing the **Quit** key does not affect the status of active calls.

**Msg/Inbox**

Press the **Inbox** key to access your call inbox.

The call inbox stores all incoming calls on an active IP Deskphone.

**Shift/Outbox**

Press the **Outbox** key to view a record of all outgoing calls.

Note: This key does not function as a *shift* key.

**Directory**

Press the **Directory** key to access the Address Book and the Friends list.

Note: You can access the Address Book while on a call and start a new call with a highlighted contact.

Avaya 1140E IP Deskphone display

Your IP Deskphone has three display areas:

- The upper display area provides the status of the line key and the programmable keys.
- The middle display area contains single-line information for items such as caller number, caller name, menu items, feature prompt strings, user-entered digits, date and time information, and phone information.
- The lower display area provides context-sensitive soft key label information.

Figure 3: IP Deskphone LCD screen

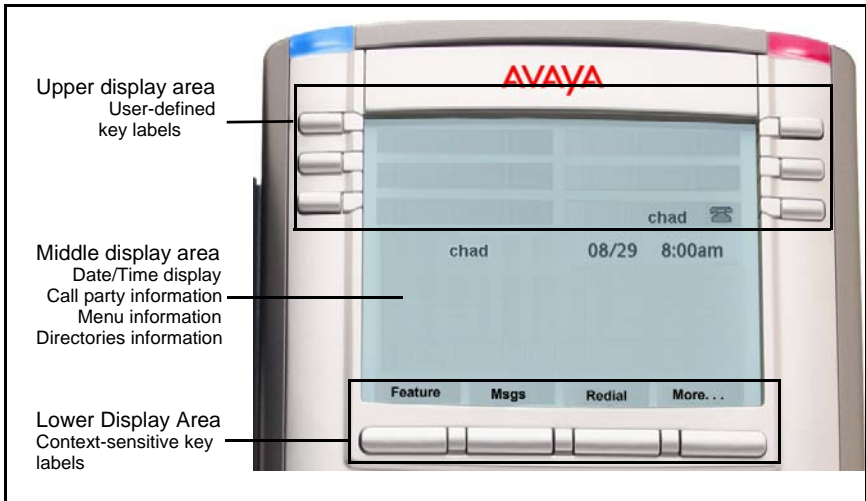

Cleaning the IP Deskphone LCD display screen

To clean the LCD display screen, gently wipe with a soft, dry cloth.

**CAUTION**

Do not use any liquids or powders on the IP Deskphone. Using anything other than a soft, dry cloth can contaminate IP Deskphone components and cause premature failure.

Context-sensitive soft keys

Your IP Deskphone has four context-sensitive soft keys beneath the LCD screen. The context-sensitive soft keys access different features and menus depending on the state of the IP Deskphone and the menu you access.

[Figure 4 on page 22](#) shows the context-sensitive soft keys while the IP Deskphone is in the idle state.

Figure 4: Context-sensitive soft keys when the IP Deskphone is in the idle state

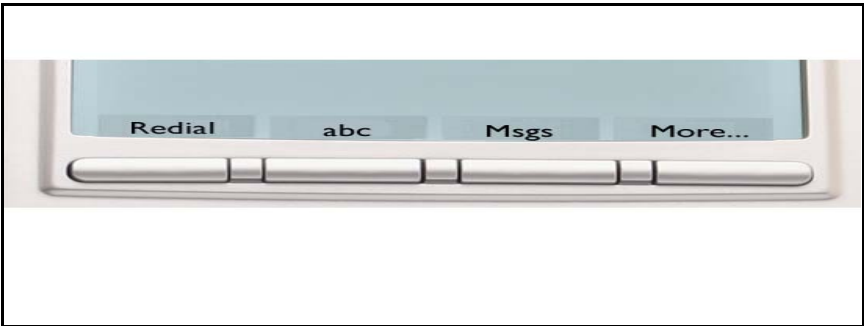

Table 1 on page 23 lists the context-sensitive soft keys that you can use to access menu items when the phone is idle.

Table 1: Menu items accessed through context-sensitive soft keys (Part 1 of 5)

| Item | Function |
|--|--|
| <p>Feature</p>  | <p>Press the Feature soft key to activate features on your phone. When you press the Feature soft key, a prompt displays, where you can enter the code of the feature you want to activate. Use the Feature soft key to activate the following functions:</p> <ul style="list-style-type: none"> — Call Forward — Forward on Busy — Forward No Answer — Private Call — Automatic Callback — Group Page — Voice/Auto Intercom — Direct Pickup — Pickup Any — Call Park/Call Park to Other — Retrieve Call — Do Not Disturb — Button Programming (Programmable keys) — Button Programming Query |

Table 1: Menu items accessed through context-sensitive soft keys (Part 2 of 5)



| Item | Function |
|--|---|
| <p>Feature</p>  | <ul style="list-style-type: none"> — Account Code — Voicemail On — Twin — Relay On — Relay — Extension Login — Extension Logout — Conference Meet Me — After Call Work — Follow Me Here/Cancel — Follow Me To — Call Record |
| <p>More...</p>  | <p>When you press the More... context-sensitive soft key, a different selection of context-sensitive soft keys appears.</p> |
| <p>Msgs</p>  | <p>Press the Msgs context-sensitive soft key to access the following features:</p> <ol style="list-style-type: none"> 1. Voice Mail—use to call your Voice Mail number. 2. Missed Call Notification—use to access your Missed Call details. |

Table 1: Menu items accessed through context-sensitive soft keys (Part 3 of 5)



| Item | Function |
|--|--|
| <p data-bbox="174 363 389 391">Redial or NewCall</p>  | <p data-bbox="483 290 921 391">Press the Redial context-sensitive soft key to redial the last dialed number.</p> <p data-bbox="483 410 932 565">If there is no stored redial number, the NewCall context-sensitive soft key appears and has the same effect as pressing the primary user line key (dial prompt).</p> |
| <p data-bbox="219 639 344 667">abc or 123</p>  | <p data-bbox="483 596 919 699">Press the abc or 123 context-sensitive soft key to toggle between alpha and numeric input modes.</p> <ul data-bbox="483 719 921 951" style="list-style-type: none"> <li data-bbox="483 719 921 808">• To type letters, the abc context-sensitive soft key must be displayed. <li data-bbox="483 828 921 951">• To type numbers, press the abc context-sensitive soft key to display the 123 context-sensitive soft key on the menu list. |

Table 1: Menu items accessed through context-sensitive soft keys (Part 4 of 5)



| Item | Function |
|--|---|
| <p data-bbox="245 313 314 342">Prefs</p>  | <p data-bbox="481 313 932 375">Press the Prefs context-sensitive soft key to display the Preferences menu.</p> <p data-bbox="481 394 932 423">The menu items include the following:</p> <ol data-bbox="481 443 932 1263" style="list-style-type: none"> <li data-bbox="481 443 932 505">1. Display—use to adjust the display settings of the LCD screen. <li data-bbox="481 524 932 647">2. Audio—use to adjust tones and volume settings, access the Codecs menu to configure a USB headset. <li data-bbox="481 667 932 823">3. Feature Options—use to configure the following: <ul data-bbox="529 745 868 823" style="list-style-type: none"> <li data-bbox="529 745 793 774">— Call Ignore Action <li data-bbox="529 794 868 823">— Missed Call Notification. <li data-bbox="481 842 932 904">4. Language—use to change the interface language. <li data-bbox="481 924 932 1263">5. Misc Options—use to access the following options: <ul data-bbox="529 1002 809 1263" style="list-style-type: none"> <li data-bbox="529 1002 740 1031">— Alpha Dialing <li data-bbox="529 1050 763 1079">— Search Method <li data-bbox="529 1099 785 1128">— Incoming Privacy <li data-bbox="529 1148 785 1177">— Outgoing Privacy <li data-bbox="529 1196 809 1226">— Hold Mode: Private <li data-bbox="529 1245 641 1274">— Time |

Table 1: Menu items accessed through context-sensitive soft keys (Part 5 of 5)

| Item | Function |
|--|---|
| <p>Prefs</p>  | <p>6. Network—use to access the following:</p> <ul style="list-style-type: none"> — Server Settings — Device Settings — Diagnostics — Disable screensaver — Licensing — Lock <p>7. USB Locks—use to lock or unlock the following USB devices:</p> <ul style="list-style-type: none"> — USB Mouse — USB Keyboard — USB Headset — USB flash drive |
| <p>Prefs</p>  | <p>8. User Settings - use to modify the following:</p> <ul style="list-style-type: none"> — Call Settings |

Idle display screen after dial pad input



After you enter information using the dial pad (there is no dial tone or preceding line selection), the context-sensitive soft keys displayed on the idle screen appear as shown in [Figure 5 on page 28](#).

Figure 5: Idle display screen after dial pad input

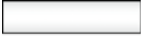

Table 2 on page 28 lists the context-sensitive soft keys that you can use to access menu items after dial pad input.

Table 2: Menu items accessed after dial pad input through context-sensitive soft keys

| Item | Function |
|---|--|
| <p>Send</p>  | <p>Press the Send context-sensitive soft key to dial out the user input using the primary login of the IP Deskphone.</p> <p>User input is run against the dialing plan.</p> |
| <p>abc or 123</p>  | <p>Press the abc or 123 context-sensitive soft key to toggle between alpha and numeric input mode.</p> |
| <p>Subject</p>  | <p>Press the Subject context-sensitive soft key to set a subject line to your outgoing call before pressing the Send context-sensitive soft key.</p> |
| <p>Exit</p>  | <p>Press the Exit context-sensitive soft key to clear the user input and return to the initial idle screen that displays the following context-sensitive soft keys:</p> <p>[Redial] [abc] [Msgs] [More...].</p> |

In-call context-sensitive soft keys

When a call is active, use the context-sensitive soft keys to access the menu items shown in [Figure 6 on page 29](#).

Figure 6: In-call context-sensitive soft keys



[Table 3 on page 29](#) lists the context-sensitive soft keys you can use to access menu items during an in-call session.

Table 3: Menu items accessed during an in-call session through context-sensitive soft keys (Part 1 of 9)



| Item | Function |
|--|--|
| <p style="text-align: center;">Trnsfer</p> <div style="text-align: center;">  </div> | <p>Press the Trnsfer context-sensitive soft key to transfer the current call to another location or to another contact.</p> |
| <p style="text-align: center;">Audio</p> <div style="text-align: center;">  </div> | <p>Press the Audio context-sensitive soft key to access the following features:</p> <p>Tones</p> <ul style="list-style-type: none"> • Ring Pattern <ul style="list-style-type: none"> — Select test patterns from 1 to 8 • Alerting Volume <ul style="list-style-type: none"> — Set Desired volume |

Table 3: Menu items accessed during an in-call session through context-sensitive soft keys (Part 2 of 9)

| Item | Function |
|--|---|
| <p>Audio</p>  | <p>Voice</p> <ul style="list-style-type: none"> • Set the volume for the following: <ul style="list-style-type: none"> — Handset Volume — Headset Volume — Handsfree Volume <p>Codecs</p> <p>Select the Audio Codecs:</p> <ul style="list-style-type: none"> • G722 (wideband codec) • PCMU (standard u-law) • G729 (729 codec) • PCMA (standard a-law) <p>Headset Selection</p> <p>Select the active headset device:</p> <ul style="list-style-type: none"> • Wired, USB (if wired, then select type 1, 2 or 3) • Enable HID Commands (enable or disable) • MHA Headset Type: • MHA Back Light (enable or disable) |

Table 3: Menu items accessed during an in-call session through context-sensitive soft keys (Part 3 of 9)

| Item | Function |
|------|---|
| | <p>Bluetooth Setup</p> <ul style="list-style-type: none"> • Enable Bluetooth (enable or disable) • To unpair Device select UnPair. <p>If Bluetooth is enabled, select:</p> <ul style="list-style-type: none"> • Search devices (IP Deskphone searches the bluetooth devices and lists the discovered devices in the Found field. • To set an Active device select Set. • To pair with a found device select Pair. • To unpair Device select UnPair. <p>Note: You can change the audio settings to improve audio quality based on the available band width. If the Internet bandwidth is low, you can improve the audio quality by changing the audio setting to low.</p> <ul style="list-style-type: none"> • Monitor Audio Quality—used to view details about the audio quality of an active call. <p style="text-align: center;">OR</p> |

Table 3: Menu items accessed during an in-call session through context-sensitive soft keys (Part 4 of 9)



| Item | Function |
|---|---|
| <p>Activate</p>  | <p>The Activate context-sensitive soft key appears when the call is not active. The most common usage of this key is when the call displayed onscreen is a call that was parked against the user (or a call that the user placed on hold).</p> <p>Note: The Activate context-sensitive soft key never appears at the same time as the Audio context-sensitive soft key.</p> |
| <p>More...</p>  | <p>Press the More... context-sensitive soft key to select a new menu list of context-sensitive soft keys (three menu lists are available).</p> <p>When you press the More... context-sensitive soft key, a different selection of context-sensitive soft keys appears.</p> |

Table 3: Menu items accessed during an in-call session through context-sensitive soft keys (Part 5 of 9)



| Item | Function |
|--|--|
| <p>More...</p>  | <ul style="list-style-type: none"> If you press the More... context-sensitive soft key once from the first menu list, you access the following context-sensitive soft keys: [NewCall] [More....] If you press the More... context-sensitive soft key from the first menu list twice, you access the following context-sensitive soft keys: [Prefs] [] [] [More...] If you press the More... context-sensitive soft key from the first menu list three times, you return to the first menu list with the following context-sensitive soft keys. [Conf] [Trnsfer] [Audio] [More... |
| <p>When you press the More... context-sensitive soft key for the first time, the following context-sensitive soft keys appear on the menu list.</p> | |
| <p>NewCall</p>  | <p>Press the NewCall context-sensitive soft key to obtain a dial tone to place another call during an active call or to a make a conference call.</p> <p>The NewCall context-sensitive soft key behaves like the Conf context-sensitive soft key.</p> |

Table 3: Menu items accessed during an in-call session through context-sensitive soft keys (Part 6 of 9)



| Item | Function |
|---|---|
| <p>More...</p>  | <p>Press the More... context-sensitive soft key to select a new menu list of context-sensitive soft keys.</p> <p>The next available menu list contains the following context-sensitive soft keys:</p> <p>[Prefs] [] [] [More...]</p> |
| <p>When you press the More... context-sensitive soft key for the second time, the following context-sensitive soft keys appear on the menu list.</p> | |
| <p>Prefs</p>  | <p>Press the Prefs context-sensitive soft key to display the Preferences menu.</p> <p>The menu items include the following:</p> <ol style="list-style-type: none"> 1. Display—use to adjust the display settings of the LCD screen. |

Table 3: Menu items accessed during an in-call session through context-sensitive soft keys (Part 7 of 9)

| Item | Function |
|--|---|
| <p>Prefs</p>  | <ol style="list-style-type: none"> 2. Audio—use to adjust tones and volume settings, to configure a USB headset, and to access the Bluetooth wireless technology setup. 3. Feature Options—use to configure the following: <ul style="list-style-type: none"> — Call Ignore Action — Missed Call Notification 4. Language—use to change the interface language. 5. Misc Options—use to access the following options: <ul style="list-style-type: none"> — Alpha Dialing — Search Method — Incoming Privacy — Outgoing Privacy — Hold Mode: Private — Time |

Table 3: Menu items accessed during an in-call session through context-sensitive soft keys (Part 8 of 9)

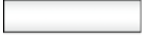

| Item | Function |
|--|--|
| <p>Prefs</p>  | <ul style="list-style-type: none"> 6. Network—use to access the following: <ul style="list-style-type: none"> — Server Settings — Device Settings — Diagnostics — Disable screensaver — Licensing — Lock 7. USB Locks—use to lock or unlock the following USB devices: <ul style="list-style-type: none"> — USB Mouse — USB Keyboard — USB Headset — USB flash drive 8. User Settings—use to modify the following: <ul style="list-style-type: none"> — Call Settings |
| <p>More...</p>  | <p>Press the More... context-sensitive soft key to return to the first menu list of context-sensitive soft keys.</p> <p>The next available menu list contains the following context-sensitive soft keys:</p> <p style="text-align: center;">[Conf] [Trnsfer] [Audio] [More...]</p> |

Table 3: Menu items accessed during an in-call session through context-sensitive soft keys (Part 9 of 9)

| Item | Function |
|---|--|
| Unlock  | The Unlock context-sensitive soft key appears if you answer a call when the IP Deskphone is locked with a password protected screensaver. |

Navigation keys

This section provides information about keys you can use to navigate within the menus of your Avaya 1140E IP Deskphone.

Note: Menu items are sorted by number.

You can select menu items in one of the following ways:

- Press the corresponding number on the dialpad and then press the **Select** soft key.
- Use the navigation key to scroll through the menu to highlight the item you want to select and then press the **Select** soft key.

Table 4 on page 38 describes the navigation keys and their functions.

Table 4: Navigation keys and functions (Part 1 of 2)



| Key | Function |
|---|--|
| <p>Navigation Key Cluster</p>  | <p>Press the Left or Right arrows on the Navigation Key Cluster to:</p> <ul style="list-style-type: none"> • Scroll long lines of text when you view caller ID. <p>Note: The IP Deskphone automatically scrolls long lines of text from right to left for entries such as in your address book or your Call Inbox. When your Search Method is set to Index Search, you can increase the speed of the scrolling by repeatedly pressing the right navigation key or decrease the scrolling speed by repeatedly pressing the left navigation key. For more information, see “Searching for a contact in the Address Book” on page 169.</p> <ul style="list-style-type: none"> • Change the slide adjustment from left to right when you adjust such things as contrast or volume. |
| <p>Navigation Key Cluster</p>  | <p>Press the right side of the Navigation Key Cluster to:</p> <ul style="list-style-type: none"> • Create a space when you enter and edit text. • View the details of the selected call log entry in the Inbox and the Outbox. |

Table 4: Navigation keys and functions (Part 2 of 2)

| Key | Function |
|---|---|
| <p data-bbox="139 261 412 289">Navigation Key Cluster</p>  | <p data-bbox="472 261 905 321">Press the left side of the Navigation Key Cluster to:</p> <ul data-bbox="472 342 929 558" style="list-style-type: none"> <li data-bbox="472 342 908 396">• Move cursor to the left when you enter and edit text. <li data-bbox="472 435 929 558">• Leave the detail view of the Inbox or Outbox and return to the main Inbox or Outbox. Operates like the Back context-sensitive soft key. <p data-bbox="472 579 894 639">Press the up or down arrows on the Navigation Key Cluster to:</p> <ul data-bbox="472 660 908 938" style="list-style-type: none"> <li data-bbox="472 660 887 721">• Erase a character (backspace) when you enter and edit text. <li data-bbox="472 742 908 829">• Highlight items in a list, such as Address Book entries or items in your Call Inbox. <li data-bbox="472 850 908 938">• Move the cursor from line to line when entering and editing text or data. <p data-bbox="520 959 923 1052">Note: To scroll through a list of items, you can press and hold the up or down key.</p> |

Using a USB Mouse

The Avaya 1140E IP Deskphone is equipped with a USB port in which you can connect a USB mouse. You can use the USB mouse to activate context-sensitive soft key items and menu items.

Use your mouse to click a context-sensitive soft key label of the LCD screen to activate that item. When a menu is open, double-click on a menu item to activate it or click on the item to highlight it. For example, you can click the **View** context-sensitive soft key label to open that menu. Double-click the word **Inbox** in the menu list; you can then double-click a

name in the Inbox list to initiate a call, or click the item to highlight the name.

To access the Network menu, right-click anywhere on the display.

Note: USB mouse support is available for the IP Deskphone but does not extend to added Expansion Modules.

Available Avaya 1140E IP Deskphone call features

The IP Deskphone is supported by the Avaya IP Office 8.0 call server. Your system administrator uses IP Office to assign call features to your IP Deskphone. To determine which features are available or to activate features, contact your system administrator or service provider.

Note: Not all service providers support the entry of a SIP address to initiate a call, for example, jim@company.com. Some service providers require that you enter a Directory Number (DN) to initiate a call, for example, 555-5555. Contact your system administrator to determine whether your call server supports SIP address dialing.

Security features

Before you can use your Avaya 1140E IP Deskphone, an ID and password must be assigned to your IP Deskphone. This security measure ensures that, after you log off, calls cannot be made from your IP Deskphone and features such as Address Book and Call Outbox are inaccessible. Your ID and password also prevent unauthorized access to your user profile.

Secure connection

Call security is identified by the presence of a security icon (padlock)  that is displayed on the IP Deskphone screen.

After the IP Deskphone is registered with the SIP Proxy, you can view the security icon when:

- the IP Deskphone is idle
- you are on an active call

Regulatory and safety information

This equipment has been tested and found to comply with the limits for a Class B digital device, pursuant to part 15 of the FCC Rules. These limits are designed to provide reasonable protection against harmful interference in a residential installation. This equipment generates, uses and can radiate radio frequency energy and, if not installed and used in accordance with the instructions, may cause harmful interference to radio communications. However, there is no guarantee that interference will not occur in a particular installation. If this equipment does cause harmful interference to radio or television reception, which can be determined by turning the equipment off and on, the user is encouraged to try to correct the interference by one or more of the following measures:

- Reorient or relocate the receiving antenna.
- Increase the separation between the equipment and receiver.
- Connect the equipment into an outlet on a circuit different from that to which the receiver is connected.
- Consult the dealer or an experienced radio/ TV technician for help.

Note: The user should not make changes or modifications not expressly approved by Avaya. Any such changes could void the user authority to operate the equipment

This Class B digital apparatus complies with Canadian ICES-003. Cet appareil numérique de la classe B est conforme à la norme NMB-003 du Canada.

Warnings:

- This is a Class B product. In a domestic environment this product can cause radio interference in which case the user must take adequate measures.
- Operation is subject to the following two conditions: (1) this device may not cause interference, and (2) this device must accept any interference, including interference that may cause undesired operation of the device."
- Privacy of communications may not be ensured when using this IP Deskphone.

- This equipment complies with FCC radiation exposure limits set forth for an uncontrolled environment. This equipment should be installed and operated with a minimum distance of 20cm between the radiator and your body (excluding the handset). This transmitter must not be collocated or operated in conjunction with any other antenna or transmitter.

To prevent radio interference to the licensed service, this device must be operated indoors only and should be kept away from windows to provide maximum shielding.

この装置は、情報処理装置等電波障害自主規制協議会（VCCI）の基準に基づくクラスB情報技術装置です。この装置は、家庭環境で使用することを目的としていますが、この装置がラジオやテレビジョン受信機に近接して使用されると、受信障害を引き起こすことがあります。

取扱説明書に従って正しい取り扱いをして下さい。

Table 5 lists EMC compliance for various jurisdictions.

Table 5: EMC compliance (Part 1 of 2)

| Jurisdiction | Standard | Description |
|---------------------------|---------------------------|---|
| United States | FCC CFR 47 Part 15 | Class B Emissions: FCC Rules for Radio Frequency Devices (see Notes 1 and 2) |
| Canada | ICES-003 | Class B Emissions: Interference-Causing Equipment Standard: Digital Apparatus |
| Australia/ New Zealand | AS/NZ CISPR22 CISPR 22 | Class B Emissions: Information technology equipment - Radio disturbance |

Table 5: EMC compliance (Part 2 of 2)

| Jurisdiction | Standard | Description |
|--------------------|--------------|---|
| European Community | EN 55022 | Class B Emissions: Information technology equipment - Radio disturbance |
| | EN 55024 | Information technology equipment - Immunity characteristics Limits and methods of measurement |
| | EN 61000-3-2 | Limits for harmonic current emissions (equipment input current \leq 16 A per phase) |
| | EN 61000-3-3 | Limitation of voltage fluctuations and flicker in low-voltage supply systems for equipment with rated current \leq 16 A |
| Japan | VCCI | Regulations for voluntary control measures. |

Table 6 lists Safety compliance for various jurisdictions.

Table 6: Safety compliance

| Jurisdiction | Standard | Description |
|-----------------------|---------------------|---|
| United States | UL 60950-1 | Safety of Information Technology Equipment |
| Canada | CSA 60950-1-30 | Safety of Information Technology Equipment |
| European Community | EN 60950-1 | ITE equipment - Safety - Part 1: General requirements |
| Australia/New Zealand | AS/NZS 60950.1:2003 | Safety of Information Technology Equipment |

Other

US/Canada: Hearing Aid Compatibility (HAC) as per FCC Part 68

This equipment complies with the CE Marking requirements. 

EU Countries: This device complies with the essential requirements and other relevant provisions of Directive 1999/5/EC. A copy of the Declaration may be obtained from <http://support.avaya.com/css/appmanager/public/support>.

Australia: AS/ACIF S004: Voice Frequency Performance Requirements for Customer Equipment

DenAn regulatory notice for Japan

Warning

Please be careful of the following while installing the equipment:

- Please only use the Connecting cables, power cord, AC adaptors shipped with the equipment or specified by Avaya to be used with the equipment. If you use any other equipment, it may cause “failures, malfunctioning or fire”.
- Power cords shipped with this equipment must not be used with any other equipment. In case the above guidelines are not followed, it may lead to death or severe injury

警告

本製品を安全にご使用頂くため、以下のことにご注意ください。

- 接続ケーブル、電源コード、ACアダプタなどの部品は、必ず製品に同梱されております。添付品または指定品をご使用ください。添付品・指定品以外の部品をご使用になると故障や動作不良、火災の原因となることがあります。
- 同梱されております付属の電源コードを他の機器には使用しないでください。上記注意事項を守らないと、死亡や大怪我など人身事故の原因となることがあります。

Getting Started

This section provides information about how to use the IP Deskphone. Carefully read each section before you operate the new IP Deskphone.

The following sections describe details about the IP Deskphone:

- [“Before you begin” on page 47](#)
- [“Connecting the components” on page 47](#)
- [“Entering text” on page 57](#)
- [“Accessing the IP Deskphone” on page 64](#)
- [“Configuring the Avaya 1140E IP Deskphone” on page 81](#)

Before you begin

**CAUTION****Damage to Equipment**

Do not plug your Avaya 1140E IP Deskphone into a regular telephone jack. This can result in severe damage to the IP Deskphone. Consult your system administrator to ensure that you plug your IP Deskphone into a 10/100/1000 BaseT Ethernet jack.

**CAUTION**

Your IP Deskphone is designed for use in an indoor environment only.

**CAUTION**

Do not plug your IP Deskphone into an Integrated Service Digital Network (ISDN) connection. Severe damage to the IP Deskphone can result.

Connecting the components

Figure 7 on page 48 shows the connections on the Avaya 1140E IP Deskphone.

Figure 7: IP Deskphone connections

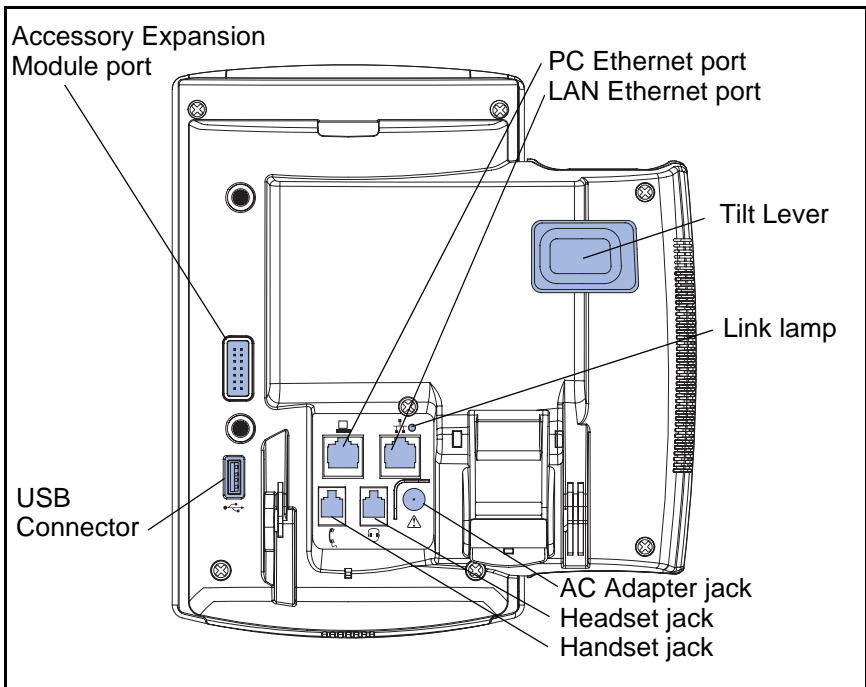

WARNING Ensure that the protective rubber cap on the Expansion Module port is in place when the port is not in use. Connection of anything other than the proper Expansion Module connector to this port can cause damage to the IP Deskphone.

Install your IP Deskphone by completing the following procedures in the order listed:

- “Removing the stand cover” on page 49
- “Connecting the AC power adapter (optional)” on page 50
- “Connecting the handset” on page 51
- “Connecting the headset (optional)” on page 52
- “Connecting the LAN ethernet cable” on page 53
- “Installing additional cables” on page 54

- “Wall-mounting the IP Deskphone (optional)” on page 54

Figure 8: Wall-mount lever

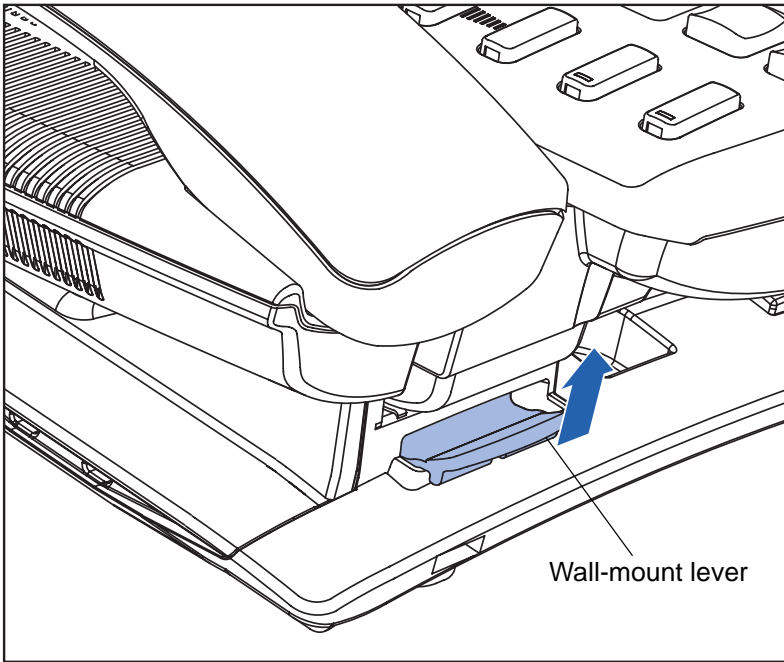

WARNING Your Avaya 1140E IP Deskphone is shipped with the base locked in position. To prevent damage to your IP Deskphone, press the wall-mount lever, located under the Handsfree key as indicated in the previous figure, to release the base and pull it away from the IP Deskphone.

Removing the stand cover

To access the cable routing tracks and attach cables, you must remove the stand cover. Pull upward on the center catch as indicated in the following figure, and remove the stand cover. The cable routing tracks are now accessible.

Figure 9: Remove the stand cover

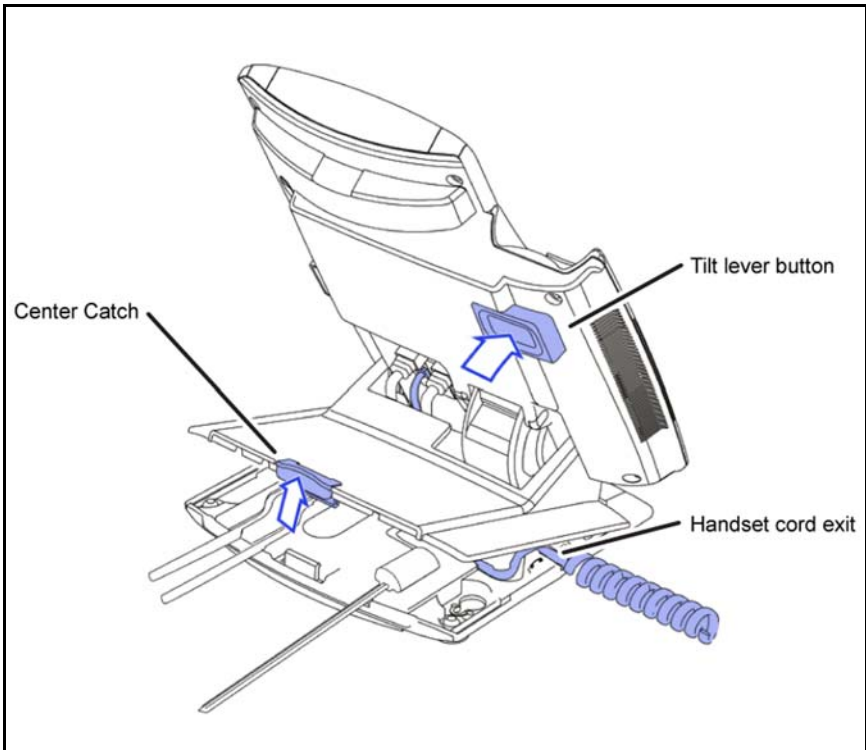

Connecting the AC power adapter (optional)

Your IP Deskphone supports AC power and Power over Ethernet (PoE) options, including IEEE 802.3af standard power. For AC power, use the Avaya AC adapter only. You can order the optional Avaya AC adapter (N0023000) separately.



WARNING

Use only the approved Avaya AC Adapter (model #N0023000) with your IP Deskphone.

To connect the AC adapter to the AC adapter jack in the bottom of the IP Deskphone use the following procedure:

1. Form a small bend in the cable.
2. Thread the adapter cord through the channels in the stand.

To use PoE, your connected LAN must support PoE. A PoE-enabled LAN delivers power to your IP Deskphone over the CAT-5 network cable and an AC adapter is not required.



**WARNING**

If you are connected to a PoE connection do not use the AC power adapter

To use gigabit Ethernet, you must connect to the LAN through CAT-5e (or later) cables.



Connecting the handset

Use the following procedure to connect the handset to the IP Deskphone.

1. Connect the end of the handset cable with a short straight section to the handset.
2. Connect the end of the handset cable with the long straight section, into the RJ-9 handset jack marked with the  symbol on the back of the IP Deskphone.
3. Form a small bend in the cable.
4. Thread the handset cord through the channels in the stand so that it exits behind the handset on the right side, using the handset cord exit in the stand base marked with the  symbol as shown in [Figure 9 on page 50](#).

Connecting the headset (optional)

Perform the following procedure to connect the optional headset to the IP Deskphone.

1. On the back of the IP Deskphone, plug the headset connector into the RJ-9 headset jack marked with the  symbol.
2. Thread the headset cord, along with the handset cord, through the channels in the stand so that the headset cord exits the channel marked with the  symbol

Selecting the headset tuning parameter

You can select a headset from the following list of supported headsets.

- Type 1: Monaural and Binaural headset
 - Monaural headset: Plantronics Model number: H251N (Part number: 64338-01) with cable Model Number: A10 (Part Number: 66268-02)
 - Binaural headset: Plantronics Model number: H261N (Part number: 64339-01) with cable Model Number: A10 (Part Number: 66268-02)
- Type 2: Monaural and Binaural headset
 - Monaural headset: Plantronics Model number: HW251N (Part number: 75100-06) with cable Model Number: A10 (Part Number: 66268-02)
 - Binaural headset: Plantronics Model number: HW261N (Part number: 75101-06) with cable Model Number: A10 (Part Number: 66268-02)
- Type 3: Binaural headset
 - Binaural headset: GN Netcom Model number: GN 4800 (Part number: 48492-09)

After you select a headset, the corresponding tuning parameters are applied automatically.

Perform the following procedure to select a headset.



1. Press **Prefs**.
2. Select **Audio**.
3. Select **Headset Type**.

Connecting the LAN ethernet cable



Note: Your IP Deskphone supports both AC power and PoE options, including IEEE 802.3 standard power. To use local AC power, you can order the optional AC adapter separately. To use PoE, where power is delivered over the CAT5 cable, the LAN must support PoE, and you do not need an AC adapter.

To enable full functionality of your IP Deskphone, connect your IP Deskphone to your LAN using a CAT5e Ethernet cable. If your network is equipped with PoE, you can power your IP Deskphone through the LAN port.

To connect your IP Deskphone to your LAN use the following procedure:

1. Connect one end of the supplied Ethernet cable to the back of your IP Deskphone by using the RJ-45 connector marked with the  symbol.
2. Thread the network cable through the channel marked with the  symbol.
3. Connect the other end of the cable to your LAN Ethernet connection.

To connect your PC through your IP Deskphone use the following procedure:

1. Connect one end of the PC Ethernet cable to your IP Deskphone using the RJ-45 connector marked with the  symbol.
2. Thread the cable through the channel marked with the  symbol.
3. Connect the other end of the cable to the LAN connector on the back of your PC.

Installing additional cables

If applicable, you can plug an optional USB device such as a USB mouse or a USB keyboard into your IP Deskphone. Connect the USB cable to the USB port on the back of the IP Deskphone.

Figure 10: Cable routing tracks and mounting holes

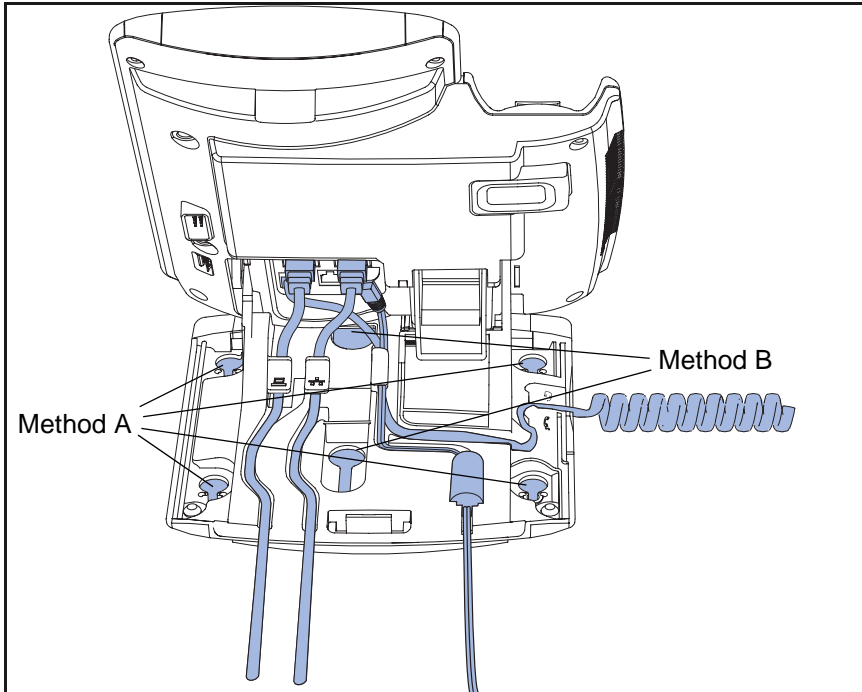

Wall-mounting the IP Deskphone (optional)

You can mount your Avaya 1140E IP Deskphone on a wall either by: (method A) using the mounting holes on the bottom of the IP Deskphone stand or (method B) using a traditional-style wall-mount box with an RJ-45 connector and 15 centimeter (cm) (6-inch) RJ-45 cord (not provided).

Complete steps 1-7, as needed, before you wall-mount your IP Deskphone:

Method A:

1. Press the wall-mount lever, and pull the IP Deskphone away from the stand, as shown in [Figure 11 on page 56](#).
2. Use the stand cover (the part you removed in [“Removing the stand cover” on page 49](#)), to mark the wall-mount holes by pressing the bottom of the stand cover firmly against the wall in the location where you wish to install the IP Deskphone. Four small pins on the bottom of the stand cover make marks on the wall.
3. Use the marks as a guideline for installing the wall-mount screws (not provided). Install the screws so that they protrude 3 millimeters (mm) (1/8 inch) from the wall.
4. Install the IP Deskphone stand mounting holes over the screw heads as indicated in [Figure 10 on page 54](#) (Method A). You need to remove the IP Deskphone from the wall to adjust the lower screws.
5. When the lower screws are snug, install the IP Deskphone on the mounting screws, and then tighten the top screws.

Figure 11: Rotate the IP Deskphone into the wall mount

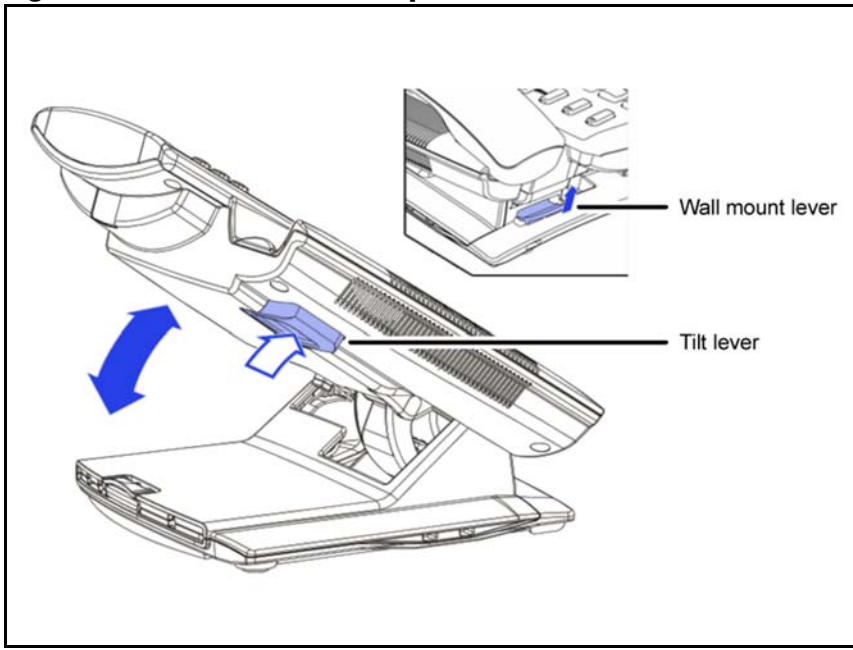

position.

Method B:

1. Attach the 15-cm (6-inch) CAT5e cable.
2. Position the stand over the mounting rivets, and slide the IP Deskphone down the wall so that the rivets fit into the slots on the stand, indicated in [Figure 10 on page 54](#) (Method B).
3. Replace the stand cover. Ensure that all cables are neatly routed and press the stand cover into place until you hear a click.
4. Put the IP Deskphone in the wall-mount position (optional). If you wall-mount your IP Deskphone, put it in the wall-mount position by holding the Tilt Lever and pressing the IP Deskphone towards the base until the IP Deskphone is parallel with the base. Release the Tilt Lever and continue to push the IP Deskphone towards the base until you hear an audible click. Ensure the IP Deskphone is securely locked in position.

Attention: To add an Expansion Module for Avaya 1100 Series IP Deskphones see *Expansion Module for Avaya 1100 Series IP Deskphones* ((NN40050-118).

Entering text

You can use combinations of the letters and numbers on the dialpad of your IP Deskphone to, for example, enter SIP addresses, create Address Book entries, and to designate feature key labels.

To make a call, you can dial an alphanumeric SIP address; for example, jdoe2@domain.com. You can enter and edit text on your IP Deskphone using the following methods:

Note: Some service providers support only the use of a Directory Number (DN) such as 555-5555 to initiate a call to another IP Deskphone. Contact your system administrator or service provider to determine if alphanumeric dialing is supported. Alphanumeric dialing consists of string of text that contain letters and numbers that make up, for example, a SIP address.

You can use the following methods to enter and edit text on your IP Deskphone:

- “Entering text using the IP Deskphone dialpad” on page 58
- “Entering text using the USB keyboard” on page 62

Entering text using the IP Deskphone dialpad

For applications that offer text input, when you use the dialpad to enter text the system activates the **abc/123** context-sensitive soft key.

You can toggle between numeric and alphabetic input as follows:

- When the context-sensitive soft key label is **abc**, you can enter alphabetic text.
- When the context-sensitive soft key label is **123**, you can enter numbers.

Figure 12: Context-sensitive soft key abc/123



For example, if you want to enter the lower case letter a, press the **abc/123** context-sensitive soft key to toggle to alphabetic input. Then press the number **2** key once. If you want to enter the upper case letter C, press the number **2** key six times. You can cycle through the letters (and the numeral) by pressing the number button repeatedly.

To create names or words that contain two adjacent letters that appear on the same button, for example, the word *press*, you can do the following:

1. To enter the first character, press the dialpad key **6**.
2. Pause briefly.

- To enter the next letter, press the dialpad key 6 twice to cycle to the letter r.

When entering alphanumeric information, the **1** key on the dialpad represents the characters in [Table 7 on page 59](#). To enter a special character, press the dialpad number **1** to cycle through the characters until you reach the one you need. For example, to enter a question mark (?), press the number **1** key eight times.

Table 7: Alphanumeric characters for dialpad key 1 (Part 1 of 2)

| Character | Name |
|-----------|-------------------|
| @ | at |
| . | period |
| - | dash |
| _ | underscore |
| & | ampersand |
| ' | apostrophe |
| ^ | carat |
| ? | question mark |
| ! | exclamation point |
| (| left parentheses |
|) | right parentheses |
| , | comma |
| \ | backslash |
| / | forward slash |
| : | colon |

Table 7: Alphanumeric characters for dialpad key 1 (Part 2 of 2)

| Character | Name |
|-----------|------------|
| ; | semi-colon |
| ~ | tilde |
| = | equal |
| + | plus |
| 1 | numeral 1 |

Note: No letters are associated with the 0 key.

Configuring the dialpad to alphanumeric dialing

To eliminate the need to press the **abc/123** context-sensitive soft key when you enter text, you can set the IP Deskphone dialpad default to alphabetic mode.

To configure the dialpad to alphabetic mode as the default:

Prefs

1. Press the **Prefs** context-sensitive soft key, and then select **Misc Options**. Highlight **Alpha Dialing**, and then press the **Change** context-sensitive soft key.

2. Choose one of the following:

On

or

Back

- Press the **On** context-sensitive soft key to turn on alphanumeric dialing.
- Press the **Back** context-sensitive soft key to keep existing configurations and return to the **Preferences** menu.

To disable alphabetic mode and set numeric mode as the default:

Prefs

1. Press the **Prefs** context-sensitive soft key, and then select **Misc Options**. Highlight **Alpha Dialing**, and then press the **Change** context-sensitive soft key.

2. Choose one of the following:

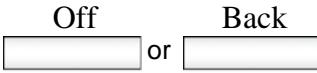

- Press the **Off** context-sensitive soft key to turn on alphanumeric dialing.
- Press the **Back** context-sensitive soft key to keep existing configurations and return to the **Preferences** menu.

Entering text using the USB keyboard

You can connect a USB keyboard to the USB port of your IP Deskphone to enter text and numbers, access some features, and duplicate some functions.

For example, to dial a directory number, you can use the keyboard number pad to enter digits and the asterisk (*) and octothorpe (#) characters and you can use the alphabetic keys to enter text.

[Table 8 on page 62](#) describes the associations between the USB keyboard function keys and the IP Deskphone fixed keys.

Table 8: USB keyboard functions (Part 1 of 2)

| USB Keyboard Key | IP Deskphone Fixed Key |
|------------------|------------------------|
| Esc | Quit |
| F1 | Services |
| F2 | Expand |
| F3 | Inbox |
| F4 | Outbox |
| F5 | Address Book |
| F6 | Copy |
| F7 | Volume Down |

Table 8: USB keyboard functions (Part 2 of 2)

| USB Keyboard Key | IP Deskphone Fixed Key |
|------------------|-----------------------------------|
| F8 | Volume Up |
| F9 | Mute |
| F10 | Hold |
| F11 | Headset |
| F12 | Handsfree |
| Break | Goodbye (Release) |
| Backspace | Left arrow of Navigation Cluster |
| Arrow Left | Left arrow of Navigation Cluster |
| Arrow Right | Right arrow of Navigation Cluster |
| Arrow Up | Up arrow of Navigation Cluster |
| Arrow Down | Down arrow of Navigation Cluster |
| Enter | Enter |

Accessing the IP Deskphone

You require a log on ID and a password to log on to a server with your IP Deskphone.

Logging on for the first time

Whenever you log on to your IP Deskphone you must do the following:

- confirm your logon ID
- enter your password
- select the duration of this session

If your system administrator has configured your Deskphone with your user logon and password, you can use the deskphone without further configuration. For more information, see [“Automatic login” on page 64](#).

The first time you use your IP Deskphone, you need to complete some of the following procedures:

- [“Configuring the domain” on page 65](#)
- [“Selecting a language” on page 67](#)
- [“Logging on to your Avaya 1140E IP Deskphone” on page 68](#)
- [“Configuring the duration of the login” on page 72](#)
- [“Selecting a location” on page 74](#)
- [“User Profile” on page 75](#)

Note: The system automatically logs you back on after a power outage or firmware upgrade. The system administrator configures this feature on a network-wide basis.

Automatic login

Before you first receive your IP Deskphone, your system administrator can configure your IP Deskphone with your user logon and password. If this is the case, after you plug in the IP Deskphone you can use it without further configuration.

Note: If the IP Deskphone is configured with automatic logon, you can not use the log off function, and you need a password to access some features and functions. Contact your system administrator or service provider for further information.

Configuring the domain

Before the log on process, if you need to change the domain or confirm that the domain you log on to is correct, press the **Domain** context-sensitive soft key from the logon prompt. The current domain appears on the IP Deskphone LCD screen. You can edit the domain that is listed or press the **Domain** context-sensitive soft key to access a list of available domains to which you can choose to connect.

Note: You must enter the admin password to edit domains.

Note: Check with your system administrator before editing or changing domains.

To change the domain:



1. Press the **Domain** context-sensitive soft key to change the current domain.

Note: You must enter an admin password before you can edit the domain in which the IP Deskphone connects.



2. Press the **Up/Down** navigation key to highlight the new domain you want to use.

Select

Back

3. Choose one of the following:

- Press the **Select** context-sensitive soft key to change the domain to the highlighted domain from the list. The IP Deskphone returns to the **Current Domain** page, and the new domain appears.
- Press the **Back** context-sensitive soft key to keep existing configurations and return to the previous menu.

Password protection for domains

This feature supports admin password protection for editing of the domain and is not required for switching domains. If you log on using the administrator password, you can use the editing domain option for both the Current Domain state and Domain List state.

After you press **back** on the edit page or on the password prompt, the idle display appears. You must enter the admin password to reenter the editing domain.

Password check to switch domains

When no one is logged on, a domain soft key appears. When you press the domain soft key, the current domain page appears without a password query.

Password protection for editing domain

When you press **Edit** for a domain, the admin password prompt appears. The editing domain page appears after you enter the correct admin password. If you do not enter the correct password, the message “incorrect password” appears with a prompt to retry.

Password request in server settings mode

When you edit the domain from the server settings under the Network menu, you are prompted to enter the admin password. After you enter the password, the Domain page appears. When you press the **Edit** context-

sensitive soft key, there is no prompt for the admin password because you have already entered the admin password to load the Server Settings menu.

Selecting a language

Your IP Deskphone has the capacity to operate using other languages. The system administrator can configure which languages are available to use for the menus on the phone. The administrator can make up to five languages available.

If the IP Deskphone is provisioned with other languages, you can select a language from a list of available options.

To change the language:

More



1. Press the **More** soft key.

Prefs



2. Press the **Prefs** soft key.



3. Use the navigation key to highlight the **Language** option.

Select



4. Press the **Select** soft key.

The screen displays the current language.

Change



5. Press the **Change** soft key.

The phone displays a list of language options.



6. Use the navigation key to highlight a language.

Select



7. Press the **Select** soft key.

The screen will change to the new language selected.

Exit



8. Press the **Exit** soft key to return to the main screen.

Logging on to your Avaya 1140E IP Deskphone

You need to log on to your Avaya 1140E IP Deskphone when you first install and restart your IP Deskphone and anytime you log off or reboot.

Note: When you log on to the IP Deskphone for the first time, the system prompts you for a location. For more information, see [“Selecting a location” on page 74](#).

Note: The IP Deskphone retains the previous user logon ID, which appears after the ID prompt whenever the IP Deskphone reboots.

If Authentication is enabled by your system administrator, you can enter your authentication ID independent of your user ID. The authentication ID is used when the server challenges the IP Deskphone.

To logon to the Avaya 1140E IP Deskphone:

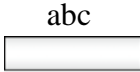

1. Press the **abc/123** context-sensitive soft key to toggle between alphabetic or numeric input.



2. Use the dialpad to enter your user ID login at the prompt.

Note: Use the left navigation key to backspace and remove a previous user ID.

Login

abc



Login

Login

3. Press the **Login** context-sensitive soft key.

If Authentication is enabled by your system administration, you are presented with the Authentication ID screen. The authentication ID is autofilled with your user ID.

If Authentication is not enabled, a new screen appears and prompts you for your password.

- a. Press the **abc/123** context-sensitive soft key to toggle between alphanumeric or numeric input.
- b. Use the dialpad to enter your authentication ID login at the prompt.
- c. Press the **Login** context-sensitive soft key.

A new screen appears and prompts you for your user password.



4. Enter your password by using the dialpad.

Note 1: When you enter your password, the last character entered appears. However, all previous characters are hidden.

Note 2: When you enter your password and you use the navigation key to backspace, you erase all the characters and must completely reenter your password again.

Next



Cancel



5. Press the **Next** context-sensitive soft key.

Note: You can cancel the login process by pressing one of the following keys:

- Cancel
- Goodbye
- Quit



Configuring the duration of the login

After you enter your logon ID and password the **Duration** screen appears. You can enter the maximum length of time of the session. If you choose to use the default duration Permanent, you remain logged on to the IP Deskphone until you log off.

To configure the login duration:

Next

Timed

Period



Next

1. Choose one of the following:
 - Press the **Next** context-sensitive soft key to set the logon duration to Permanent. A login confirmation screen appears.
 - Press the **Timed** context-sensitive soft key to open a screen to set a maximum time to remain logged in.

Note: If you press the **Timed** context-sensitive soft key, you must then set the duration of the login.

2. Press the **Period** context-sensitive soft key to toggle the logon duration entries between hours or days.
3. Do one of the following:
 - Use the dialpad to enter the number of hours or days you want to remain logged on and press the **Next** context-sensitive soft key.

Back



- Press the **Back** context-sensitive soft key to return to the permanent logon screen.

Cancel



- Press the **Cancel** context-sensitive soft key to return to the first logon screen.

Timed logoff

When you determine a logon time other than permanent, the IP Deskphone reminds you of your expiry time.

Timed logoff while IP Deskphone is idle

When the login time expires and the IP Deskphone is idle (not on a call), you can do one of the following at the prompt:

- Press the **Yes** context-sensitive soft key to log off immediately.
- Press the **No** context-sensitive soft key to switch to Permanent logon.
- Press the **Quit** or **Release/Goodbye** key to logout immediately.

If you do not respond, the prompt times out in 45 seconds and the IP Deskphone logs off.

If you answer a call during the logout prompt, the logon switches to permanent login.

Timed logoff while on a call

When the login time expires while you are on a call, you can do one of the following at the prompt:

- Press the **Yes** context-sensitive soft key to log off immediately.
- Press the **No** context-sensitive soft key to switch to Permanent logon.
- Press the **Quit** key to dismiss the log out prompt and switch to permanent login.

- Press the **Release/Goodbye** key to dismiss the logout prompt and switch to permanent login.

Note: If you press the **Release/Goodbye** key to dismiss the logout prompt, you also terminate the call.

If you do not respond, the prompt times out in 45 seconds and the IP Deskphone switches to permanent login.

Selecting a location

When you first login to the IP Deskphone, the system prompts you for a location. The location you select is saved in your User Profile.

Depending on your service provider, the Enhanced Emergency Service uses the location you select or the Directory Number (DN) on the call server, when handling emergency calls. The configuration of the call server determines how emergency service calls are handled by your IP Deskphone.

Note 1: During an emergency call, you cannot log out from the IP Deskphone or release or disconnect the call. The IP Deskphone remains connected to the emergency service until the emergency service operator disconnects it.

Note 2: If the login time expires during an emergency call, a prompt does not appear and the IP Deskphone automatically switches to permanent login.

Note 3: When you set your user profile for the first time, you must confirm that the selected location is correct. You can view your location by accessing the Phone Information screen. For more information, see [“Viewing the IP Deskphone information” on page 237.](#))

User Profile

Your User Profile contains your specific settings and data. You are prompted to create a User Profile the first time you log on to your Avaya 1140E IP Deskphone. If you delete your User Profile, the IP Deskphone reboots, and you must log on and create a new User Profile. When you log on to your IP Deskphone, your specific settings and data are automatically available for you.

The information stored in your user profile includes:

- Independent volume adjustments for handset, headset, and handsfree
- Alerting Volume adjustment
- Idle Screen display text
- Display Contrast and Backlight Screen Saver settings
- Voice Mail settings (number and mailbox ID)
- User location (from a server-provided list)
- Time, Date, and Zone format settings
- Default dialing (alpha/numeric)
- Call Ignore action (local/network)
- Search method (Name, First character, Index)
- Dialing pattern default (alpha/numeric)
- Address Book entries
- Call Inbox and Call Outbox entries
- Programmable keys configuration

Confirmation logon screen

When you complete the logon process, the logon confirmation screen appears. Press the **OK** context-sensitive soft key to complete the logon process.

If the login is unsuccessful, a login error message `Failed to login user, Authentication required` appears. Press the **OK** context-sensitive soft key to return to the first logon screen. The most common cause for logon failure is the incorrect entry of your password.

Note: In case of login failures, the IP Deskphone displays the message “Failed to login user” and then automatically returns to the login screen.

Logging off from the IP Deskphone

To log off from the IP Deskphone:



Services

1. Press the **Services** fixed key, and then select **Logout** from the menu.

abc



2. Press the **abc/123** context-sensitive soft key to toggle between alphabetic or numeric input.



3. Use the dialpad to enter your password at the prompt.

Logout

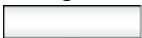

or

Back







4. Choose one of the following:
 - Press the **Logout** context-sensitive soft key to complete the logout process. The IP Deskphone returns to the **User Login** screen.
 - Press the **Back** context-sensitive soft key to remain logged on and return to the Services menu.

Logging on and off from a different extension

This feature allows you to log on to a different deskphone using your own extension number.

To log on from a different deskphone

- | | |
|--|---|
| <p>Feature</p>  | 1. Press the Feature soft key. |
| <p>Elogl</p>  | 2. Press the Elogl soft key. The screen displays <code>Extension login?</code> |
| <p>Yes</p>  | 3. Press the Yes soft key. The deskphone displays the following prompt: <code>User ID:></code> |
|  | 4. Using the key pad, enter the extension number of your deskphone. |
| <p>Done</p>  | 5. Press the Done soft key. The deskphone displays the following prompt: <code>Password:></code> |



- Using the key pad, enter the password for your deskphone.

The deskphone displays the confirmation message `Login OK`.

To log off from a different deskphone

Feature



- Press the **Feature** soft key.

ElogO



- Press the **ElogO** soft key.

The screen displays `Extension logout?`

Yes



- Press the **Yes** soft key.

The deskphone displays the following prompt: `Password:>`



- Using the key pad, enter the extension number of your deskphone.

Done



- Press the **Done** soft key.

The deskphone displays the confirmation message `Logout OK`.

Making an emergency call

You can use the IP Deskphone to make an emergency call to the Public Safety Answering Point (PSAP) from any accessible screen without logging on.

When you pick up the handset, press the handsfree button or headset button without logging on, a message “**Emergency calls only**” appears, and the IP Deskphone can only be used to make an emergency call. All context-sensitive soft keys and feature keys are blank and unusable except for the second context-sensitive soft key which allows you to switch between numeric and alphabetic characters. If you hang up before the connection is established, the Avaya 1140E IP Deskphone returns to the initial state.

Note: When the IP Deskphone is waiting for the user to log on or it is blocked by a screen saver, you can still make an emergency call. If you pick up the handset, a message "Emergency calls only" appears and the IP Deskphone can be used for making only emergency calls.

To make an emergency call:



1. Choose one of the following:
 - Pick up the handset.
 - Press the handsfree button.
 - Press the headset button.

Note: Hang up or switch off the handset to return to normal state.

2. Dial the emergency number that is provided by your dialing plan.
3. Press the **Send** context-sensitive soft key.

Send



Note: If you try to dial the number that does not match the dialing plan, a message appears to inform you that the number is incorrect.

Configuring the Avaya 1140E IP Deskphone

You can adjust a few settings of the Avaya 1140E IP Deskphone to conform to the environment where you want to use the phone. These settings are saved to your User Profile. This chapter describes some of the settings that you can customize on your IP Deskphone.

- “Adjusting the display screen contrast” on page 81
- “Creating the idle screen text display” on page 82
- “Configuring the Backlight Screensaver” on page 83
- “Configuring Menu Auto back-out” on page 84
- “Selecting a ring pattern” on page 86
- “Adjusting the volume” on page 87
- “Selecting a language” on page 92
- “Selecting the date and time format” on page 93
- “USB headset” on page 97

Adjusting the display screen contrast

Note: Adjusting the display screen contrast of the IP Deskphone also adjusts the Expansion Module contrast, if you have an Expansion Module connected to your IP Deskphone.

To adjust the display screen contrast:



1. Press the **Prefs** context-sensitive soft key, select **Display, Display Settings** and then select **Contrast**.



2. Press the **Left/Right** navigation key to increase or decrease the display contrast level.

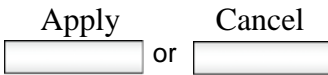

3. Choose one of the following:
 - Press the **Apply** context-sensitive soft key to save the changes and return to the **Display** menu.
 - Press the **Cancel** context-sensitive soft key to keep the existing configurations and return to the **Display** menu.

Creating the idle screen text display

You can create a text to display on the screen, while the phone is idle.

To create the idle screen display text:



1. Press the **Prefs** context-sensitive soft key, select **Display**, and select **Idle Screen Text Display**.

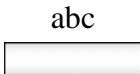

2. Press the **abc/123** context-sensitive soft key to toggle between alphabetic or numeric input.



3. Use the dialpad to enter the display text you want to appear on the idle screen display of the IP Deskphone.

- Choose one of the following:

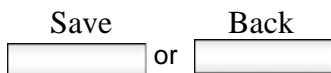

- Press the **Save** context-sensitive soft key to save the idle screen text display.
- Press the **Back** context-sensitive soft key to keep the existing screen display text and return to the **Display** menu.

Configuring the Backlight Screensaver

To configure the amount of time the LCD screen remains backlit:



- Press the **Prefs** context-sensitive soft key, select **Display**, **Display Settings** and then select **Backlight Screensaver** from the menu.



- Press the **Left/Right** navigation key to increase or decrease the length of time you want the idle screen to remain backlit.

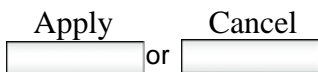

- Choose one of the following:
 - Press the **Apply** context-sensitive soft key to configure the length of time for the phone to remain backlit and return to the **Display** menu.
 - Press the **Cancel** context-sensitive soft key to keep the existing configurations and return to the **Display** menu.

Configuring Menu Auto back-out

You can use the Menu Auto back-out feature to configure the time interval required for the IP Deskphone to go back to the idle screen when the IP Deskphone is left inactive.

To configure Menu Auto back-out:

Prefs



1. Press the **Prefs** context-sensitive soft key, choose **Display**, and then **Menu Auto back-out**.

2. Choose one of the following:

Select



or

Back



- Press the **Select** context-sensitive soft key.
- Press the **Back** context-sensitive soft key to return to the previous menu.



3. Press the **Up/Down** navigation key to scroll through the screen and choose the required time interval.

Choose one of the following values:

- Never
- 10 min
- 5 min
- 2 min
- 1 min
- 30 sec
- 15 sec

Note: The Never option turns off Menu Auto back-out.

4. Choose one of the following:

Select or Back

- Press the **Select** context-sensitive soft key to configure the Auto back-out time to the selected (highlighted) value and return to the Display menu.
- Press the **Back** context-sensitive soft key to dismiss the Auto back-out time menu and return to the Display menu.

Note: When you enter the Auto back-out menu, the current configuration for the Menu Auto back-out time is pre-selected (highlighted) on the list.

When you press the **Select** context-sensitive soft key, the time interval is flagged to commit to the configured preferences (done after the idle screen is displayed), and is used for menu auto back-outs from that point forward.

Selecting a ring pattern

You can use the ring pattern feature to select the ring pattern for an incoming call.

To select the ring pattern for an incoming call:

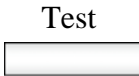

1. Press the **Prefs** context-sensitive soft key, select **Audio**, select **Tones**, and then select **Ring Pattern**.
2. Press the **Up/Down** navigation key to scroll through and highlight the different ring patterns displayed on the LCD screen.
3. Choose one of the following:
 - Press the **Select** context-sensitive soft key to configure the ring pattern and return to the Tones menu.
 - Press the **Test** context-sensitive soft key to briefly play the selected ring pattern.
 - Press the **Back** context-sensitive soft key to keep the existing configurations and return to the previous menu.

Adjusting the volume

You can adjust the volume of the IP Deskphone for the following:

- Ring Volume
- Handset Volume
- Headset Volume
- Handsfree Volume

A sliding scale appears on the LCD screen display when you adjust the volume. [Figure 13 on page 87](#) shows how to adjust the volume.

Figure 13: Adjusting the volume



Adjusting the ring volume

You can adjust the ring volume for an incoming call.

To adjust the ring volume for an incoming call:



1. Press the **Prefs** context-sensitive soft key, select **Audio**, select **Tones**, and then select **Alerting Volume**.



2. To adjust the ring volume of an incoming call do one of the following:
 - Press the **Left/Right** navigation key.
 - Press the **Volume** fixed keys to increase or decrease the volume.

Set



or

Back



3. Choose one of the following:
 - Press the **Set** context-sensitive soft key to configure the selected volume and return to the **Tones** menu.
 - Press the **Back** context-sensitive soft key to keep the existing configurations and return to the **Tones** menu.

Adjusting the volume of the Handset, headset, and Handsfree mode

You can adjust the volume for the handset, headset, and the handsfree speaker of the IP Deskphone.

To adjust the volume of the handset:

Prefs



1. Press the **Prefs** context-sensitive soft key, select **Audio**, select **Voice**, and then select **Handset**.

2. To adjust the handset volume use one of the following methods:



- Press the **Left/Right** navigation key to increase or decrease the volume of the handset.

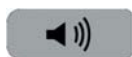

- Press the **Volume +** fixed key to increase the handset volume or press the **Volume -** fixed key to decrease the handset volume.



Note: To adjust the volume during a call, use only the **Volume +** and **Volume -** fixed keys.

3. Choose one of the following:

Set

Back

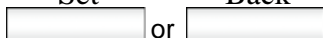

- Press the **Set** context-sensitive soft key to configure the selected volume and return to the **Voice** menu.
- Press the **Back** context-sensitive soft key to keep existing configurations and return to the **Voice** menu.

You can adjust the headset volume on the IP Deskphone.

To adjust the headset volume:

Prefs



1. Press the **Prefs** context-sensitive soft key, select **Audio**, select **Voice**, and then select **Headset**.

2. To adjust the handset volume use one of the following methods:

- Press the **Left/Right** navigation key to increase or decrease the volume of the handset.
- Press the **Volume +** fixed key to increase the handset volume or press the **Volume -** fixed key to decrease the handset volume.

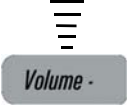

Note: To adjust the volume during a call, use only the **Volume +** and **Volume -** fixed keys.

3. Choose one of the following:

- Press the **Set** context-sensitive soft key to configure the selected volume and return to the **Voice** menu.
- Press the **Back** context-sensitive soft key to keep the existing configurations and return to the **Voice** menu.

Set



or

Back



You can adjust the handsfree mode volume on the IP Deskphone.

To adjust the handsfree mode volume:

Prefs



1. Press the **Prefs** context-sensitive soft key, select **Audio**, select **Voice**, and then select **Handsfree**.

2. To adjust the handsfree volume use one of the following methods:



- Press the **Left/Right** navigation key to increase or decrease the volume of the handset.
- Press the **Volume +** fixed key to increase the handset volume or press the **Volume -** fixed key to decrease the handset volume.



Note: To adjust the volume during a call, use only the **Volume +** and **Volume -** fixed keys.

3. Choose one of the following:

Set

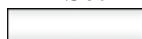

or

Back



- Press the **Set** context-sensitive soft key to configure the selected volume and return to the **Voice** menu.
- Press the **Back** context-sensitive soft key to keep the existing configurations and return to the **Voice** menu.

Selecting a language

The display is available in multiple languages. A maximum of five languages are accessible through the IP Deskphone. The system administrator determines which languages are available for your IP Deskphone.

To select a language:

Prefs



1. Press the **Prefs** context-sensitive soft key, and then select **Language**. The current language displays.

Change



2. Press the **Change** context-sensitive soft key to change the language.



3. Press the **Up/Down** navigation key to scroll and highlight the desired language (for example, German [Deutsche]).

Select



or

Back

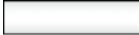

4. Choose one of the following:
 - Press the **Select** context-sensitive soft key to save the desired language and return to the previous screen.
 - Press the **Back** context-sensitive soft key to keep the existing configurations and return to the **Preferences** menu.

Selecting the date and time format

Several date and time formats are available. Formats are based on the 12-hour and 24-hour clocks.

o select a date format:

Prefs



1. Press the **Prefs** soft key.



2. Press the **Up/Down** navigation key to highlight **Misc Options** in the menu.

Select



3. Press the **Select** soft key.



4. Press the **Up/Down** navigation key to highlight **Time** in the menu.

Change



5. Press the **Change** soft key.

The screen displays a series of options.



6. Press the **Up/Down** navigation key to highlight **Date Format** in the menu.

Change



7. Press the **Change** soft key.



Select



8. Press the **Up/Down** navigation key to scroll and select the format you want to use.

9. Press the **Select** soft key to save the format.

10. Press the **Back** soft key to return to the menu and press the **Exit** soft key to return to the main screen.

Back



and

Exit



The IP Deskphone provides the ability for you to select a time zone; however, your system administrator sets the time zone on the IP Office caller server. Your selection will be overwritten if the system administrator has configured the time zone differently.

To select a time zone:

Prefs



1. Press the **Prefs** soft key.



2. Press the **Up/Down** navigation key to highlight **Misc Options** in the menu.

Select



3. Press the **Select** soft key.



4. Press the **Up/Down** navigation key to highlight **Time** in the menu.

Change



5. Press the **Change** soft key.
The screen displays a series of options.



6. Press the **Up/Down** navigation key to highlight **Timezone** in the menu.

Change



7. Press the **Change** soft key.



8. Press the **Up/Down** navigation key to scroll through and highlight the time zones.

Note: Time zones are listed based on GMT format, for example:

- GMT -11:00 Samoa
- GMT -10:00 Hawaii

Select



9. Press the **Select** soft key.

10. Press the **Back** soft key to return to the menu and press the **Exit** soft key to return to the main screen.

Back



and

Exit



You can select the time zone format for your IP Deskphone.

To select a time format:

Prefs



1. Press the **Prefs** soft key.



2. Press the **Up/Down** navigation key to highlight **Misc Options** in the menu.

Select



3. Press the **Select** soft key.



4. Press the **Up/Down** navigation key to highlight **Time** in the menu.

Change



5. Press the **Change** soft key.
The screen displays a series of options.



6. Press the **Up/Down** navigation key to highlight **Time Format** in the menu.

Change



7. Press the **Change** soft key.



8. Press the **Up/Down** navigation key to scroll and highlight a time format:
 - 12-hour
 - 24-hour
 - French

9. Press the **Back** soft key to return to the menu and press the **Exit** soft key to return to the main screen.



USB headset

You can attach only one USB headset to the IP Deskphone. (If you add an additional USB headset, the IP Deskphone ignores it without any message.) When you connect the USB headset to the USB port of the IP Deskphone, the IP Deskphone configures the headset to work with it.

[Table 9 on page 97](#) lists the types of USB headsets that work with the IP Deskphone.

Table 9: Supported USB headset types

| Headset type | Frequency |
|---|------------------------------|
| Avaya Enhanced USB headset adapter | 8 KHz |
| Avaya Mobile USB headset adapter | 8 KHz |
| Plantronics CS50/CS60 Wireless USB headsets | 8-48 KHz Continuous Spectrum |
| GN Netcom 9300 series wired and wireless USB headsets | 16 KHz |
| Algo Analog Terminal Adapter | 8 KHz |

Headset menu

The USB Audio feature adds the USB headset as an alternative headset in addition to the wired and the Bluetooth headset. You can add a headset to your preferences by clicking on the **Prefs** context-sensitive soft key, and then choosing **Audio**. The Audio option allows you to select and configure the preferred headset. [Figure 14 on page 98](#) displays the Audio menu with the **Headset Selection** menu item.

Figure 14: Preferences menu with headset menu item

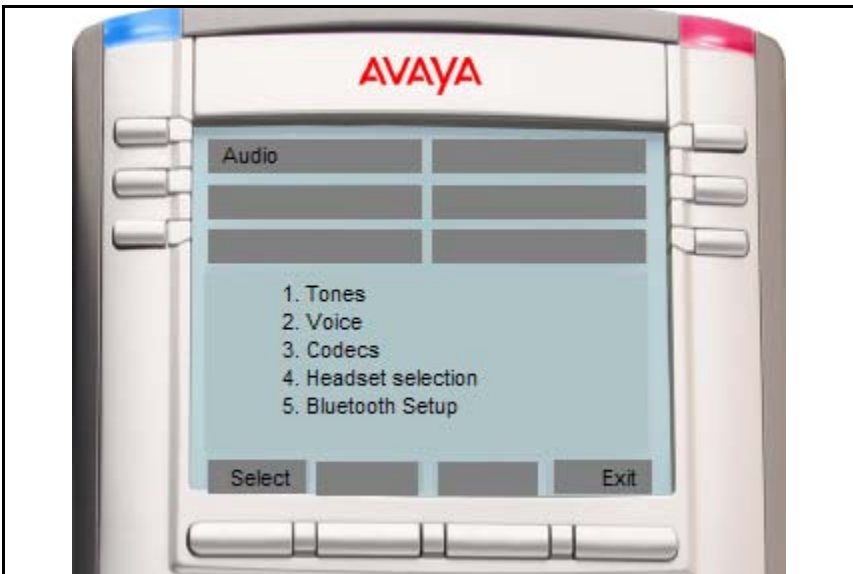

On the IP Deskphone, after you select the **Prefs**, **Audio**, and **Headset Selection** menu items, use the headset screen to select the desired headset and corresponding functional parameters. [Figure 15 on page 99](#) displays the headset screen.

Figure 15: Headset screen

Headset

Active Headset Device: USB ▼

Wired Headset Type: Headset Type 1 ▼

Enable HID Commands:

MHA Headset Type: Avaya Mobile Kit ▼

MHA Back Light:

Apply Cancel

Table 10 on page 100 describes the configuration options on the headset screen.

Table 10: Configuration options on the headset screen (Part 1 of 3)

| Option | Function |
|-----------------------|---|
| Active Headset Device | <p>Select the active headset device; either USB, Wired, or Bluetooth.</p> <p>Note: The headset can be selected before it is paired (Bluetooth) or attached (wired or USB).</p> <p>Items below the Active Headset Device field are dimmed, if either USB headset is not selected or if the attached headset is not one of the Human Interface Device (HID) supported headset types.</p> |
| Wired Headset Type | <p>Select the type of wired headset you required.</p> <ul style="list-style-type: none"> • Headset Type 1 (Generic narrow band) • Headset Type 2 (Wideband) • Headset Type 3 (Wideband) |

Table 10: Configuration options on the headset screen (Part 2 of 3)

| Option | Function |
|---------------------|---|
| Enable HID Commands | <p>Enable HID Commands only if USB headset is selected.</p> <p>The checkbox is used to enable the HID commands of supported headsets to allow the IP Deskphone to run in generic mode 1 operation, supporting both USB audio and HID commands. The configuration is ignored for non-supported USB headsets.</p> |
| MHA Headset Type | <p>Choose an MHS Headset Type only if Avaya headset adapter is detected.</p> <p>This list contains the different wired headset types that can be attached to the Avaya Enhanced or Mobile Adapters for loss plan adjustment. The command is ignored for other types of USB headsets. This item is dimmed if the attached headset is not one of the Avaya headset types.</p> |

Table 10: Configuration options on the headset screen (Part 3 of 3)

| Option | Function |
|----------------|---|
| MHA Back Light | <p>Enable the MHA Back Light (only if Avaya headset adapter is detected).</p> <p>The checkbox is used to enable or disable the back light equipped in Avaya Enhanced or Mobile headsets. The command is ignored for other types of USB headsets. This item is dimmed if the attached headset is not one of the Avaya headset types.</p> |

The changes in the menu take effect immediately if the device is attached. The active voice path switches to the selected headset if you are on an active call. If you press the **Apply** context-sensitive soft key, then the changes are applied, the settings are made permanent by storing the values in persistent storage, and they are applied every time the IP Deskphone starts up. However, all changes made are ignored and restored if you press the **Back** context-sensitive soft key.

Presence of USB headset

On the **System** menu, choose **Phone Information**, and then select **USB** to verify the presence of the USB headset attached to the IP Deskphone. When you select the **USB** menu, the attached USB headset is displayed along with other USB devices. The name of the USB device directly appears from the USB devices themselves. The product description has no explicit USB headset indications for the attached USB headset. The following figure displays the headset setting screen.

Figure 16: Presence of USB headset screen

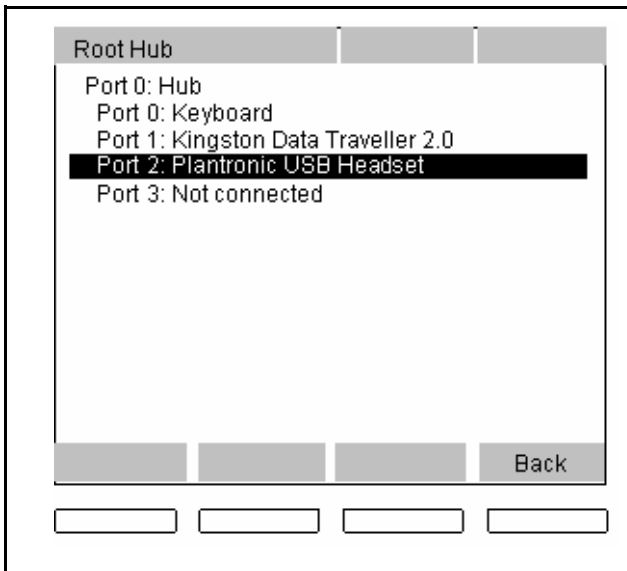

Audio format selection

After the IP Deskphone receives the endpoint configurations, it searches the records to select an audio format that matches the IP Deskphone requirements. If no match is found, then the default audio format is used. After you select the format, the IP Deskphone sends a command to the device to select the corresponding endpoints for audio transfers.

The IP Deskphone supports both 8KHz and 16KHz audio. You can select the 16KHz audio, if the headset supports it. The IP Deskphone is a mono device with only one voice channel. For stereo USB headsets detected, the IP Deskphone replicates one channel voice data to both left and right channels of the headsets to simulate stereo output. The following table lists the audio format requirements supported by the IP Deskphone.

Table 11: Supported USB audio formats

| Audio Parameters | Values |
|------------------|----------|
| Audio Format | PCM only |

| Audio Parameters | Values |
|------------------|--|
| Subframe size | 2 |
| Bit Resolution | 16 bits |
| Frequency Type | Continuous (0) or Discrete (> 0) |
| Sample Frequency | If Continuous, default to 16 KHz. If Discrete, 8 KHz, 16KHz or 8KHz multiple. Preference is given to 16KHz audio, if supported |
| Audio Channel | Mono (1) or Stereo (2) |

After you select the format and the Set Interface command is sent, the USB headset runs in Generic Mode 1 operation (both audio and HID) or Mode 2 operation (audio only). If the headset runs in Mode 1 operation, the IP Deskphone configures the task or callback to communicate with the USB HID control events between the IP Deskphone and the headset. You can insert the headset during an active call. The IP Deskphone synchronizes the headset state machine of the IP Deskphone to the current state of the headset to ensure the LED match status.

During the call, if the audio negotiated between the two parties is set to 8KHz audio and the IP Deskphone is setup for 16KHz USB headset audio, the IP Deskphone performs the transcoding between 8KHz audio to 16KHz audio. Likewise, if the audio negotiated between the two parties is set to 16KHz audio and the headset supports only 8KHz audio, the IP Deskphone performs the transcoding between 16KHz audio to 8KHz audio.

Generic USB headset

When a generic USB headset (or supported headset with HID command disabled) is attached to the IP Deskphone and selected, it behaves like a wired headset. All call controls, on hook, off hook, mute, volume up, and volume down are performed using the keys on the IP Deskphone. The IP Deskphone does not use the User interface elements on the headset, including LEDs if present. When the USB headset is selected, the voice path to or from the USB headset is used in an active call.

Avaya USB headset adapter with HID

When you enable the HID support for Avaya USB Mobile or Enhanced adapter, then the IP Deskphone makes use of the UI elements on the adapter. Both type of USB headsets are stimulus devices, as the IP Deskphone can have complete control of the LEDs. [Table 12 on page 105](#) lists the features of the Avaya USB headset adapter.

Table 12: Avaya USB headset adapter with HID support

| Feature | Description |
|-----------|---|
| Key Event | <p>Key press on the adapter generates events only with a state maintained and actions taken by the IP Deskphone. There is a one-to-one mapping on most of the keys on the adapter to the keys on the IP Deskphone (the Avaya Enhanced Adapter has a Avaya logo key which does not exist on the IP Deskphone). Table 13 on page 108 illustrates the mappings:</p> <p>Key press events on the adapter are sent to the IP Deskphone through the USB. When the IP Deskphone receives these events, it maps them to the corresponding key events as if the keys on the IP Deskphone are pressed.</p> |

| Feature | Description |
|--------------------|--|
| LED | There are two LEDs on the adapters, one for the mute status and the other for message waiting. These two LEDs are also mapped to the corresponding LEDs on the IP Deskphone. The IP Deskphone synchronizes the LEDs status with that of the IP Deskphone: the Mute LED for mute indication and the Message Waiting LED for message waiting and incoming call (flash) indications. The Avaya USB Enhanced Adapter has an extra port to connect an external alerter. If there is an external alerter attached, the external alerter is kept synchronized with the Message Waiting LED. |
| Attached Indicator | When a Avaya USB Mobile or Enhanced headset is connected to the IP Deskphone, after enumeration, the IP Deskphone flashes the LEDs on the headset for a short duration to indicate the headset is ready to use. |
| Back Light | Both adapters have a back light to allow easy identification of the adapters. If the back light is enabled in the headset screen, the back light of the adapter turns on after enumeration. |
| Message Waiting | If there is voice message waiting on the IP Deskphone, the IP Deskphone turns on the red message waiting LED on the IP Deskphone and on the adapter. The IP Deskphone turns off the red message waiting LED if there is no voice message waiting. |

| Feature | Description |
|-----------------------|---|
| External Alerter | The Avaya USB Enhanced Adapter has a port to allow an External Alerter (large LED indicator) to attach to the adapter. The IP Deskphone uses HID commands to keep the External Alerter synchronized with the red Message Waiting LED on the IP Deskphone and on the adapter. |
| Incoming Call | When there is an incoming call, the IP Deskphone sends an alerting event to the adapter. The red Message Waiting LED flashes to indicate there is an incoming call on the IP Deskphone. |
| Caller ID Information | Not applicable. |
| Call Answer | You can answer an incoming call by pressing the headset key on the IP Deskphone or the Off Hook (Green) key on the adapter. After a call is answered, audio data flows between the IP Deskphone and the headset adapter through the USB. |
| Outgoing Call | You can make an outgoing call by either pressing the headset key on the IP Deskphone, or the Off Hook (Green) key on the adapter. When off hook, the IP Deskphone streams dial tone to the headset. The telephone number must be dialed using the key pad of the IP Deskphone. After a call is answered, audio data flows between the IP Deskphone and the headset adapter through the USB. |
| Call Release | You can release an incoming call or an outgoing call by pressing either the On Hook (Red) key on the adapter, or the Release (Goodbye) key on the IP Deskphone. After a call is released, audio data between the IP Deskphone and the headset stops. |

| Feature | Description |
|------------------|--|
| Call Mute | Pressing the Mute key on the adapter is equivalent to pressing the Mute key on the IP Deskphone. After processing the mute event, the voice path from the IP Deskphone to the far end is muted. Both the Mute LED on the IP Deskphone and the LED on the adapter are lit to indicate the call is muted. When unmuted, the voice path resumes and both LEDs go off. |
| Volume Up/Down | Pressing the Volume Up/Down key on the adapter is equivalent to pressing the Volume Up/Down key on the IP Deskphone. After processing the Volume Up/Down events, the system volume changes and affects the volume on the attached headset. |
| Audio Processing | Same as the wired headset. Audio quality is restricted to narrow band with mono voice channel only. |

Table 13 on page 108 lists the Avaya USB adapter key mappings.

Table 13: Avaya USB adapter key mappings

| Keys on adapter | Keys on the IP Deskphone |
|-----------------|--------------------------|
| Blue Key | Expand Key |
| Green Key | Headset Key |
| Red Key | Release Key |
| Mute Key | Mute Key |
| Volume Up/Down | Volume Up/Down |

The Blue key is mapped to the Expand key on the IP Deskphone.

Third-party USB headsets with HID

Both USB Audio and USB HID commands are supported. The two classes of third-party USB headsets are as follows:

- Plantronics CS50/CS60 Wireless USB headsets
- GN Netcom 9300 series wired and wireless USB headsets

The HID support of third-party USB headsets performs differently from the Avaya headset. The headsets are independent devices with an internal state machine to control LED operations and headset behavior.

Table 14 on page 110 lists the features of a third-party USB headset with HID support.

Table 14: Third-party USB headset with HID support features (Part 1 of 5) (Part 1 of 5)

| Feature | Description |
|------------|---|
| Key Events | <p>Both types of headsets have equivalent mechanisms to generate the following key events:</p> <ul style="list-style-type: none"> • On Hook • Off Hook • Mute • Volume Up/Down <p>The headsets send the corresponding HID commands to the IP Deskphone to synchronize call processing operations. When the IP Deskphone receives these commands, the IP Deskphone maps them to the corresponding key events (except the Volume Up/Down keys) as if the keys on the IP Deskphone are pressed.</p> <p>If the corresponding keys on the IP Deskphone are used instead, the IP Deskphone sends the HID commands to the headsets to allow the headsets to update their internal state machine.</p> |
| LEDs | <p>Both types of headsets have LEDs on the base station for status indication. These LEDs are controlled by the headset base stations themselves according to their internal state machines. The IP Deskphone has no direct control of these LEDs.</p> |

Table 14: Third-party USB headset with HID support features (Part 2 of 5) (Part 2 of 5)

| Feature | Description |
|-----------------------|--|
| Attached Indicator | <p>Both types of headsets can have attached indications independent of the IP Deskphone operations.</p> <p>The GN Netcom (Jabra) 9350 headset can take over 3 seconds to complete the enumeration process after the headset is attached to the IP Deskphone. During enumeration, the LEDs at the bottom of the base station flash. The enumeration process is complete only when there is a blink at the headset piece and the base LEDs become solid.</p> |
| Back Light | Not applicable |
| Message Waiting | Not applicable |
| External Alerter | Not applicable |
| Incoming Call | When there is an incoming call, the IP Deskphone sends an alerting event to the headset. Each type of headset has different incoming call indications. |
| Caller ID Information | Not applicable |

Table 14: Third-party USB headset with HID support features (Part 3 of 5) (Part 3 of 5)

| Feature | Description |
|---------------|---|
| Call Answer | You can answer an incoming call by pressing the headset key on the IP Deskphone or the Off Hook equivalent key on the headset. The IP Deskphone coordinates the key events from both sources and performs the necessary call processing operations. Call connected indications, if available, are autonomous within the headset to match its internal state. After a call is answered, audio data flows between the IP Deskphone and the headset through the USB. |
| Outgoing Call | You can make an outgoing call by either pressing the headset key on the IP Deskphone or the Off Hook equivalent key on the headset. When off hook, the IP Deskphone streams dial tone to the headset. This class of headset has no dial pad and the telephone number must be dialed using the key pad of the IP Deskphone. After the call is connected, voice data streams between the IP Deskphone and the headset. |

Table 14: Third-party USB headset with HID support features (Part 4 of 5) (Part 4 of 5)

| Feature | Description |
|----------------|---|
| Call Release | <p>You can release an incoming call or an outgoing call by pressing either the Release (Goodbye) key on the IP Deskphone or the On Hook equivalent key on the headset. After a call is released, audio data stops between the IP Deskphone and the headset.</p> <p>If you are using the Plantronics headset, to release a call, press and hold the answer/release toggle button for more than two seconds.</p> |
| Call Mute | <p>The mute key event is handled independently on the headset. The corresponding HID command is sent to the IP Deskphone to synchronize IP Deskphone status. Mute status indication on the headset is also independent. When muted, the headset streams blank audio to the IP Deskphone and the IP Deskphone also mutes the audio to the far end (double muted).</p> |
| Volume Up/Down | <p>This class of headsets manages volume changes locally whenever Volume Up/Down keys are pressed. Pressing the Volume Up/Down keys on the headset has no effect on system volume. The IP Deskphone ignores volume events from the headsets to prevent double volume changes. On the other hand, volume changes on the IP Deskphone change the system setting and indirectly affects the volume level on the headset.</p> |

Table 14: Third-party USB headset with HID support features (Part 5 of 5) (Part 5 of 5)

| Feature | Description |
|------------------|---|
| Audio Processing | Same as the wired headset. Both headsets support Wideband audio. The IP Deskphone selects to use 16KHz audio to match the audio characteristics of the headset. |

Analog Terminator Adapter for analog (500/2500-type) telephone or fax machine

SIP Software Release 3.x supports the Analog Terminator Adapter (ATA) which is connected using the USB port. An analog (500/2500-type) telephone or fax machine can be connected to the ATA to convert the IP Deskphone to an analog system. The ATA is treated as an USB headset device by the IP Deskphone.

SIP Software 3.x supports On hook/Off hook and dial pad key events for HID support to allow the attached device to make outgoing calls directly without using the key pad on the IP Deskphone. If Calling Line ID (CLID) of the far-end is available, then the information is sent to the attached analog device. An analog (500/2500-type) telephone or fax machine that supports Calling Line ID displays the information on the screen.

Table 15 on page 115 displays the characteristics of ATA.

Table 15: Summary of ATA characteristics (Part 1 of 3)

| Feature | Description |
|-----------------------|---|
| Key Events | In addition to On hook, Off hook events, dial pad digit events from the attached analog device are also supported. Key press events on the adapter are sent to the IP Deskphone through the USB. After the IP Deskphone receives these events, it maps them to the corresponding key events as if the keys on the IP Deskphone are pressed. |
| LEDs | Not applicable. |
| Attached Indicator | Not applicable. |
| Back Light | Not applicable. |
| Message Waiting | Not applicable. |
| External Alerter | Not applicable. |
| Incoming Call | When there is an incoming call, the IP Deskphone sends an alerting event to the adapter. The adapter produces the ring tones for the attached analog device to indicate there is an incoming call on the IP Deskphone. |
| Caller ID Information | Caller ID, if available, is also sent to the adapter. The adapter sends the CLID to the attached analog device for display. |

Table 15: Summary of ATA characteristics (Part 2 of 3)

| Feature | Description |
|----------------|--|
| Call Answer | You can answer an incoming call by pressing the headset key on the IP Deskphone or the Off Hook key on the attached analog device. After a call is answered, the adapter converts the digital voice data to analog and sends it to the attached analog device. |
| Outgoing Call | You can make an outgoing call by either using the headset key on the IP Deskphone or the Off Hook key on the attached analog device. When off hook, the IP Deskphone streams dial tone to the adapter. The telephone number can be dialed using the key pad of the IP Deskphone or the key pad of the analog device. After a call is answered, the adapter converts the digital voice data to analog and sends it to the attached analog device. |
| Call Release | You can release an incoming call or an outgoing call by either pressing the Release (Goodbye) key on the IP Deskphone or On Hook key on the analog device. |
| Call Mute | Some analog devices have a mute key to stop voice transmission; however, the Mute key event on the analog device is not supported. |
| Volume Up/Down | The Volume Up/Down key on the analog device, if available, is independent of the IP Deskphone operation. |

Table 15: Summary of ATA characteristics (Part 3 of 3)

| Feature | Description |
|------------------|---|
| Audio Processing | Same as the wired headset. Audio quality is restricted to narrow band with mono voice channel only. |

Configuring Bluetooth wireless technology headset

Your IP Deskphone is equipped with a wireless audio gateway system to support Bluetooth wireless technology enabled headsets.

To open the Bluetooth Setup dialog box:



1. Do one of the following:
 - Double-press the **Headset** key quickly.
 - Press the **Prefs** context-sensitive soft key, select **Audio**, and then select **Bluetooth Setup** from the menu.

The IP Deskphone with SIP Software supports the Plantronics Voyager 510S Bluetooth wireless technology headset.

If the Bluetooth Setup menu appears dimmed or fails to open when you double-press the **Headset** key, the feature is not enabled on your IP Deskphone. Before you can use a Bluetooth wireless technology headset with your IP Deskphone, the system administrator must activate the feature. Contact your administrator to inquire if Bluetooth wireless technology functionality is available for your use.

Do not pair more than one headset of the same model because they have identical names in the **Paired** list.

Note: Do not pair more than one headset of the same model because they have identical names in the **Paired** list.

To pair a wireless headset with your IP Deskphone:



1. Double-press the **Headset** key to open the Bluetooth Setup dialog box.

The **Enable Bluetooth** check box is highlighted.

If the Bluetooth Setup menu fails to open when you double-press the **Headset** key, the Bluetooth wireless technology feature is not enabled on your IP Deskphone. Contact your administrator.



2. Press the **Enter** key to activate the Bluetooth wireless technology.

A check mark appears to indicate that the feature is activated. The message **BT Enabled** appears at the bottom of the display.

3. Put your Bluetooth wireless technology headset in its pairing or search mode. The procedure for doing this can be different for each headset. Refer to the documentation that accompanies your headset or contact the vendor.
4. Ensure that your headset is in Pairing or Search Mode.



5. Press the **Right** navigation key twice, and highlight the **Search** button, displayed next to the Search Devices item.



6. Press the **Enter** key.

The message `Searching...` appears. It can take up to two minutes for the search to complete.

If the search is successful, the message `Search Completed Found Device(s)` appears, and a list of devices that support Bluetooth wireless technology appears in the **Found** list.

7. If the search is successful, proceed to step 9.
8. If the search is not successful, the message `Search completed. No device found` appears. If this happens, or if the headset times out and exits the search/pairing mode, power off the headset, and repeat steps 4 to 8.

If pairing is still unsuccessful, pair the IP Deskphone to another wireless headset, or contact the headset vendor.

Stop



9. When the name of your headset appears in the **Found** box, press the **Stop** context-sensitive soft key or wait for the search to finish.

When the search is complete, the message `Search Completed Found Device(s)` appears.



10. If the name of your headset appears in the **Found** box, proceed to step 15.

If your headset is not displayed in the **Found** box, select your headset from the list.



11. Press the **Right** navigation key one or more times to highlight the **Found** box. Press the **Enter** key to start the edit mode.



12. Press the **Down** navigation key to open the **Found** list. Press the **Up/Down** navigation key to scroll and highlight your headset.



13. Press the **Enter** key to select the headset and close the list. Press the **Enter** key to exit edit mode.



14. Press the **Right** navigation key one or more times to highlight the **Pair** button (next to the Pair Device item) and press the **Enter** key.

A dialog box appears, with the prompt `Enter PIN#`.





15. Use the telephone dialpad to enter the PIN for the wireless headset and press the **Enter** key.

Check your headset documentation to find the headset PIN or passkey. Often, the PIN or passkey is 0000.

16. If the headset is successfully paired with your IP Deskphone, proceed to step 17. To verify that the pairing is successful, ensure that the headset appears in the list next to the **Paired** item. If pairing is successful, the message `Pair completed` also appears at the bottom of the screen.

If the headset is not successfully paired with your IP Deskphone, an error message appears at the bottom of the screen. If an error message appears:

- Confirm that the wireless headset is still in search/pair mode.
- If the headset timed out and exited search/pairing mode, put the headset in pairing mode, as discussed in step 4, and repeat step 15.
- Check that you are using the correct PIN and repeat step 15.

17. If the name of your headset appears in the **Paired** box, proceed to step 18.

If more than one device is paired, and the one you wish to use is not shown in the **Paired** box, navigate to the one you want, as follows:



- Press the **Right** navigation key one or more times to highlight the **Paired:** box. Press the **Enter** key to start the edit mode.
- Press the **Up/Down** navigation key to open the list. Press the **Up/Down** navigation key to scroll in the **Paired** list and highlight your headset.
- Press the **Enter** key to select the headset and close the list. Press the **Enter** key to exit edit mode.

18. If only one headset is paired, proceed to step 18.

If more than one wireless headset is paired, the first headset paired is automatically made the active device. To make a different headset active, do the following:

- Press the **Right** navigation key one or more times to highlight the **Set** button (next to the Set Active Device item).
- Press the **Enter** context-sensitive soft key.



The message "Set active: "device name" appears meaning that the headset named is now the active headset and is used when you press the headset key.

Exit



19. Press the **Exit** context-sensitive soft key to exit to the main display. Changes are saved automatically.

Dual pairing headsets

Take special care when using a dual pairing type of Bluetooth wireless technology headset. This type of headset can be paired to the base of the headset, as well as to the IP Deskphone. If the headset is paired to both, and the IP Deskphone is the second device, then following **applies**:

Press the **Headset** key:

- If a single tone sounds, the headset is connected to the base.
- If a double beep sounds, the headset is connected to the IP Deskphone.

- If the base is powered off, the headset is only paired to the IP Deskphone, and you can press the telephone key to connect to the IP Deskphone.

Note: Unless you need to dual pair a headset, operating the headset with the IP Deskphone is simpler if the headset is only used with its charging-only base. You should power off the desktop telephone base, if it is not in use.

Interaction with wired headsets

If you connect a Bluetooth wireless technology headset and a wired headset to the same Avaya 1140E IP Deskphone, the two interact as follows:

- If a wireless headset is not paired, the wired headset works as normal. Likewise, if a wireless headset is paired with a wired headset, but the wireless headset is not in range, the wired headset works as normal.
- If the Use BT headset checkbox is selected, the wireless headset is used as the IP Deskphone headset.

The Bluetooth wireless technology headset can work only if it is within range of the IP Deskphone. As the wireless headset approaches the edge of its wireless range, the audio quality degrades, and radio interference noise increases. When the wireless headset is in connecting range, the **Headset** key controls the wireless headset, even if a wired headset is attached. If a wireless headset moves out of connecting range, a special beep sounds in the headset to indicate that the connection is lost.

When you do not want to use your Bluetooth technology headset

If a Bluetooth wireless technology headset is connected, and you want to use the wired headset, you can switch between the two. It is not necessary to unpair or disable the wireless headset.

You can switch between a wired and wireless headset and back again when the IP Deskphone is idle or during an active call.

To switch between a wired headset and a wireless headset:



1. Double-press the **Headset** key to open the Bluetooth Setup dialog.



2. Press the **Left/Right** navigation key to select the **Use BT Headset** item.



3. Press the **Enter** key to toggle this option on or off.

A check mark indicates that the wireless headset is used. Clear the check mark to use a wired headset. This option is on (✓) by default.

To unpair a wireless headset:



1. Double-press the **Headset** key to open the Bluetooth Setup dialog box.



2. Press the **Right** navigation key to select the **Paired** item.



3. If the name of your headset appears in the **Paired** box, proceed to step 11.



4. If more than one device is paired, and your headset is not already displayed in the **Paired** box, press the **Right** navigation key one or more times to highlight the **Paired** box.



5. Press the **Enter** key to open edit mode.



6. Press the **Up/Down** navigation key to open the list.



7. Press the **Up/Down** navigation key to scroll through the list and highlight your headset.



8. Press the **Enter** key to select the headset and close the box.



9. Press the **Enter** key to exit edit mode.



10. Press the **Right** navigation key one or more times to highlight the **UnPair** button (next to the UnPair Device item).



11. Press the **Enter** key.

Your Bluetooth wireless technology headset is unpaired and removed from the **Paired** item list.

Your Bluetooth wireless technology headset is no longer paired with your IP Deskphone, and you can use the wired headset. To use the wireless headset again, you must perform the pairing and activation procedure.

Making a call

This section describes the methods you can use to make a call. You can make a call from your IP Deskphone using one of the following:

- [“Making a call using off-hook dialing” on page 129](#)
- [“Making a call using on-hook dialing” on page 131](#)
- [“Making a call using redial” on page 133](#)
- [“Making an intercom call” on page 134](#)
- [“Making paging calls” on page 135](#)
- [“Making a call using automatic callback” on page 136](#)
- [“Joining a conference call” on page 137](#)

You can also initiate a call while using one of the following features:

- [“The Address Book” on page 159](#)
- [“Call Inbox” on page 174](#)
- [“Call Outbox” on page 185](#)

When an outgoing call fails to connect to the destination, one of the following messages appears:

- Declined, Temporarily unavailable
- Declined, Cannot find user
- Declined, User has declined call

Making a call using off-hook dialing

To make a call using off-hook dialing:



abc

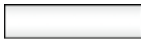

1. Make a call by using one of the following off-hook dialing methods:
 - Press the **Line** feature key
 - Lift the handset
 - Press the **Headset** fixed key
 - Press the **Handsfree** fixed key

The IP Deskphone produces a dial tone.

2. You can make a call using one of the following methods:
 - Enter the phone number or SIP address by using the dialpad.

Note: The **abc/123** context-sensitive soft key toggles between alphabetic and numeric input.

Redial



Msgs



- Press the **Redial** context-sensitive soft key to dial the last dialed number.
- Press the **Msgs** context-sensitive soft key and then select **Voice Mail** from the Messages menu to access your voice mail.
- Press the programmable key that you configured to call with a commonly used or important phone number or SIP address.

Note: You can assign a programmable key to use as a shortcut to dial a number or a SIP address.

Send (optional)



3. Choose one of the following options to initiate the call:
 - Press the **Send** soft key to immediately initiate the call.
 - Wait for the IP Deskphone to automatically initiate the call. By default, the deskphone will initiate the call after 5 seconds; however, this interval is configured by your system administrator and can be different.

Making a call using on-hook dialing

You can make a call by using on-hook dialing. Enter the SIP address or the phone number before going off-hook.

Note: When you use this method, you cannot toggle between alphabetic or numeric input.

To make a call using on-hook dialing:



1. Dial the number or SIP address.

Chad



2. Continue the call by using one of the following methods:
 - Press the **line** feature key.
 - Press the **headset** fixed key.
 - Press the **Handsfree** fixed key.

3. To terminate the call, choose one of the following:
 - Replace the handset into the cradle.
 - Press the **Goodbye** key.



Using handsfree calling

While on an active call, you can switch between the handset and handsfree mode.

To end a handsfree call:



Press the **Goodbye** key

To mute a handsfree call:



1. Press the **Mute** key.
The LED indicator lights.



2. Press the **Mute** key again to return to a two-way handsfree conversation.

To switch from the handsfree to handset mode:



Lift the handset.

To switch from the handset mode to handsfree mode:



1. Press the **Handsfree** key.
The LED indicator lights with a solid red light.



2. Replace the handset.

To use a headset:

1. Connect the headset to the headset jack or the handset jack.



Headset |

2. Press the **Headset** key. The LED indicator lights.



Goodbye |

3. Press the **Goodbye** key or press the button on the wireless headset, if equipped, to release a call.

To switch from handsfree to headset:

Headset |

1. Press the **Headset** key. The LED indicator lights.

Making a call using redial

Automatically redial the last telephone number that you dialed.

To make a call using redial:

1. Redial the last number called by using one of the following methods:

Redial



- Press the **Redial** softkey to immediately initiate the call.

Note: The **Redial** context-sensitive soft key only appears if a number or address was previously entered.

OR

Feature



- Press the **Feature** soft key.

- Press the **5** on the key pad.



Enter



- Press the **Enter** key, located in the center of the navigation key, to initiate the call.

Making an intercom call

To make a call using the intercom:

Feature



1. Press the **Feature** soft key.

IAuto



2. Press the **IAuto** soft key.

The screen displays `Voice/Auto IC?`.

Yes



Done

3. Press the **Yes** soft key.

The deskphone displays the following prompt: `Voice/Auto IC:>`

4. Enter the extension number you wish to call.

5. Press the **Done** soft key.

Making paging calls

To make a call using paging:

Feature

1. Press the **Feature** soft key.

GrpPg

2. Press the **GrpPg** soft key.

The screen displays the message `Page group?`

Yes

3. Press the **Yes** soft key.

The deskphone displays the following prompt: `GrpPg:>`



4. Enter the number (or group number) that you wish to page.

Done



5. Press the **Done** soft key.

Making a call using automatic callback

You can set an automatic callback for a user that you have called but who has not answered. When the user next ends a call, the telephone system will call you and when you answer, will automatically make a call to the user.

To make a call using automatic callback:

Feature



1. Press the **Feature** soft key.

AutoCB



2. Press the **AutoCB** soft key.

The screen displays `Automatic Callback?`

Yes



3. Press the **Yes** soft key.

The screen displays the confirmation message `Activation OK.`

To deactivate automatic callback:

Feature

1. Press the **Feature** soft key.

AutoCB

2. Press the **AutoCB** soft key.

The screen displays `Automatic
Callback?`

Yes

3. Press the **Yes** soft key to toggle the setting.

The screen displays the confirmation message `Deactivation OK.`

Joining a conference call

You can use the Conference Meet Me feature to join a specific conference call.

To join a conference call:

Feature

1. Press the **Feature** soft key.

CnfMM

2. Press the **CnfMM** soft key.

The screen displays `Conference
Meet Me?`

Yes



3. Press the **Yes** soft key.

The deskphone displays the following prompt: Conference ID:>

4. Using the key pad, enter the ID number of the conference you wish to join. The conference ID is from 1-10 digits in length.

Note: Ad hoc conferences are assigned IDs starting at 100. Use numbers outside of this range for the Meet Me conferences.

Done



5. Press the **Done** soft key.

The deskphone displays the following confirmation message: To :
Conference <#>.

Receiving a call

When you receive a call, you are typically notified by the alerting ring, and the incoming caller identification appears on the LCD screen.

Caller identification

When you receive an incoming SIP call, the Caller ID information appears on the LCD screen. When you receive a call from a contact that is entered in the IP Deskphone Address Book, the caller information appears as it is in the Address Book. See [Figure 17 on page 140](#).

You can restrict the information displayed for incoming calls or for calls you make. For more information, see [“Configuring Privacy settings” on page 221](#).

This chapter provides information about the following topics:

- [“Answering an incoming call” on page 140](#)
- [“Ignoring an incoming call” on page 141](#)
- [“Configuring Do Not Disturb” on page 142](#)
- [“Setting an interval for after-call work” on page 143](#)
- [“Receiving intercom calls” on page 145](#)
- [“Receiving calls to a pickup group” on page 145](#)
- [“Receiving paging calls” on page 147](#)
- [“Receiving voice mail” on page 148](#)
- [“Forwarding calls to another number” on page 150](#)

Figure 17: Incoming call screen

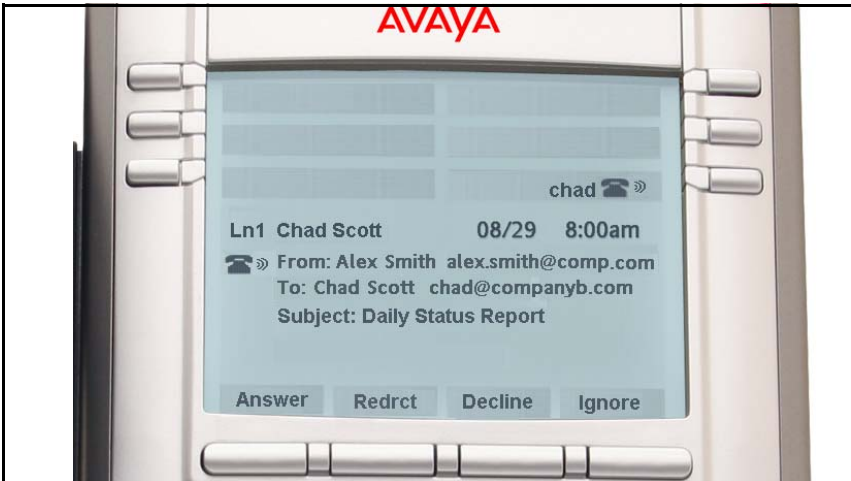

Answering an incoming call

When you can answer an incoming call, you can choose one of four methods.

To answer an incoming call:

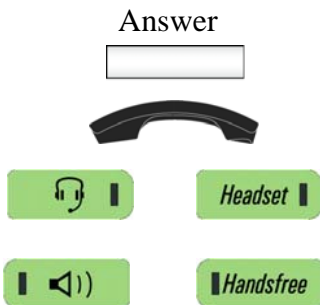

1. Choose one of the following:
 - Press the **Answer** context-sensitive soft key that activates a Handsfree call.
 - Lift the handset.
 - Press the **Headset** fixed key.
 - Press the **Handsfree** fixed key.

Ignoring an incoming call

You can terminate an incoming call alert without answering the call by pressing the **Ignore** context-sensitive soft key or by pressing the **Goodbye** fixed key. The caller continues to hear the ringing tone but is unaware that you are ignoring the call.

You can set the Call Ignore feature to either Local or Network. When Call Ignore is set to Local, only that IP Deskphone is affected, and it stops ringing when you press the **Ignore** context-sensitive soft key. When Call Ignore is set to Network and you press the **Ignore** context-sensitive soft key, the IP Deskphone stops ringing, and a message is sent to the network indicating that you are busy at all SIP IP Deskphones you are logged on to, and that server should stop trying to contact you.

To set the Ignore feature to Local or Network press the **Prefs** context-sensitive soft key, select **Feature Options**, and then select **Call Ignore Action** from the menu. Press the **Change** context-sensitive key to change the Call Ignore setting to either Call Ignore: Local, or Call Ignore: Network.

Note: When you are on active call and you receive an incoming call, do not press the **Goodbye** fixed key to ignore an incoming call. If you press the **Goodbye** fixed key, the current call disconnects. Press the **Ignore** context-sensitive soft key to ignore the incoming call.

To ignore an incoming call:

Prefs



1. Press the **Prefs** context-sensitive soft key, select **Feature Options**, and then select **Call Ignore Action** from the menu.

Change



2. Press the **Change** context-sensitive key to change the Call Ignore setting to either Call Ignore: Local or Call Ignore: Network

Ignore



Goodbye

3. To terminate an incoming call alert and ignore the incoming call, do one of the following:

- Press the **Ignore** context-sensitive soft key to terminate an incoming call.
- Press the **Goodbye** fixed key when you are not on an active call.

Configuring Do Not Disturb

You can use the Do Not Disturb feature to prevent incoming calls.

To prevent an incoming call:

Feature

DND

Yes

1. Press the **Feature** soft key.

2. Press the **DND** soft key.

The screen displays Do Not Disturb?

3. Press the **Yes** soft key.

The screen displays Do Not Disturb to indicate that the feature is activated. If you have assigned DND to a programmable key, the Do Not Disturb icon displays next to the button while the feature is active.

To cancel Do Not Disturb:

Feature

1. Press the **Feature** soft key.

DND

2. Press the **DND** soft key.

The screen displays Do Not Disturb?

Yes

3. Press the **Yes** soft key to toggle the setting.

The screen displays **Allow Calls** to confirm that incoming calls will not be blocked. The Do Not Disturb icon is removed from the screen.

If you have assigned DND to a programmable key, the Do Not Disturb icon is removed to indicate that the feature is currently inactive.

Setting an interval for after-call work

The After Call Work feature allows you to have an interval of time between disconnecting from one call and receiving another incoming CCR Agent hunt group call. During the interval, any CCR Agent hunt group calls are prevented but direct calls to your extension are received. This feature prevents incoming hunt group calls for an interval of time that is set by your system administrator.

To set an interval for after-call work:

Feature

1. Press the **Feature** soft key.

ACWrk

2. Press the **ACWrk** soft key.
The screen displays *After Call Work?*

Yes

3. Press the **Yes** soft key.
The screen displays *After Call Work* to confirm that incoming calls will be prevented.

To cancel after-call work:

Feature

1. Press the **Feature** soft key.

ACWrk

2. Press the **ACWrk** soft key.
The screen displays *After Call Work?*

Yes

3. Press the **Yes** soft key to toggle the setting.
The screen displays *Allow Calls* to confirm that incoming calls will be received.

Receiving intercom calls

Your IP Deskphone can be part of an intercom group. After you receive a call from the intercom group, the following occurs:

- You receive a call notification and the IP Deskphone rings; the display is similar to the display of a normal call.
- The IP Deskphone auto-answers the intercom call on handsfree after the configured number of seconds pass by.
- The IP Deskphone auto-answers only if you do not answer the call within the configured time limit.
- If you are on an active call, the IP Deskphone does not auto-answer the incoming intercom call.

Receiving calls to a pickup group

Your IP Deskphone can be part of a pickup group. In a pickup group, each member can answer another member's calls. The following options are available for answering calls to a pickup group:

- Group pickup: answer an incoming call to any group of which you are a member.
- Direct pickup: answer an incoming call at an extension number that is not assigned to the group.
- Pickup any: answer the first available incoming call.

Pickup groups are assigned by your system administrator.

To receive a call using group pickup:

Feature

1. Press the **Feature** soft key,

PickG

2. Press the **PickG** soft key.

The screen displays Group Pickup?

Yes

3. Press the **Yes** soft key.

To receive a pickup group call using direct pickup:

Feature

1. Press the **Feature** soft key.

DpkUp

2. Press the **DPkUp** soft key.

The screen displays Direct Pickup?

Yes

3. Press the **Yes** soft key.

The IP deskphone displays the following prompt: DpkUp> .



4. Enter the number of the phone from which you wish to pickup the call.

Done

5. Press the **Done** soft key.

To receive a pickup group call using pickup any:

- | | |
|-------------------------------------|--|
| <p>Feature</p> <input type="text"/> | <p>1. Press the Feature soft key.</p> |
| <p>PickA</p> <input type="text"/> | <p>2. Press the PickA soft key.</p> <p>The screen displays Call Pickup Any?</p> |
| <p>Yes</p> <input type="text"/> | <p>3. Press the Yes soft key.</p> |

Receiving paging calls

Your IP Deskphone can be part of a paging group. After you receive a call from the paging group, the following happens:

- The display on the screen includes a <<Paging>> tag, the From header, and optional subject.
- The IP Deskphone establishes a one-way speech path between the IP Deskphone and the caller; that is, you can only hear the call, you cannot respond.
- The IP Deskphone does not display context-sensitive soft keys.
- The IP Deskphone blocks all key events, such as line keys and digit keys, except for the Volume up and down keys, the Mute on and off key, and the Release key (Goodbye key).
- If you are on an active call, the IP Deskphone does not auto-answer the page call.
- While the page call is active, Do Not Disturb (DND) is enabled on the IP Deskphone; the IP Deskphone does not accept other incoming calls until the page call ends.

- If you are in the process of making an outgoing call and a page call comes in, the IP Deskphone ends the outgoing call and auto-answers the page call.

Receiving voice mail

The following sections describe how to use the voicemail functions on your IP Deskphone:



- [“Enabling or disabling voice mail” on page 148](#)
- [“Retrieving voice mail” on page 149](#)

Enabling or disabling voice mail

You can control whether the IP Deskphone directs your unanswered calls to voice mail.

If you enable voice mail, and later disable voicemail so that new calls are not directed to voicemail, the setting does not affect existing messages. You can continue to access existing messages and use other voicemail functions.

To enable voice mail:

- | | |
|---|--|
| Feature  | 1. Press the Feature soft key. |
| VM on  | 2. Press the VM on soft key. The screen displays <code>Voicemail On?</code> |
| Yes  | 3. Press the Yes soft key to enable voice mail. The screen displays the confirmation message <code>Voicemail On</code> . |

To disable voice mail:

Feature

1. Press the **Feature** soft key.

VM on

2. Press the **VM on** soft key.

The screen displays `Voicemail On?`

Yes

3. Press the **Yes** soft key to toggle the setting and disable voice mail.

The screen displays the confirmation message `Voicemail Off`.

Retrieving voice mail**To retrieve voice mail messages:**

Msgs

1. Choose one of the following methods:

— Press the **Msgs** soft key.

The IP deskphone immediately connects to your voice mail inbox.

OR

Feature

— Press the **Feature** soft key.



- Enter **981** on the key pad.



- Press the **Enter** key, located in the center of the navigation key.

Forwarding calls to another number

You can redirect your calls to another telephone in your system. The IP Deskphone allows you to control how your calls are redirected. The following sections describe the options for redirecting calls:

- [“Call forwarding” on page 150](#)
- [“Follow me” on page 155](#)

Call forwarding

There are three options for call forwarding:

- forward all calls immediately
- forward calls only when there is no answer at your number
- forward calls only when your line is busy

To activate call forwarding for all calls:



1. Press the **Feature** soft key.

CFwd

2. Press the **CFwd** soft key.

The screen displays `Call Forward?`

Yes

3. Press the **Yes** softkey.

All

4. Press the **All** softkey.

The screen displays the last number to which calls were forwarded.

5. Specify the number that you want to forward the calls to:

- To forward calls to the same number, press the **Enable** soft key.

OR

- To forward calls to a different number, press the **Edit** soft key and enter the number that you want to forward the calls to.

- Press the **Save** soft key to save the new number.

- Press the **Enable** soft key.

Enable

Edit

Save

Enable

The screen displays `Forward>` and the number to which calls will be forwarded.

To activate call forwarding—no answer:

- Feature
- CFwd
- Yes
- NoAns
- Enable
- Edit
- Save
- Enable
1. Press the **Feature** soft key.
 2. Press the **CFwd** soft key.
The screen displays `Call Forward?`
 3. Press the **Yes** soft key.
 4. Press the **NoAns** soft key.
The screen displays `Forward On No Answer?`
 5. Specify the number that you want to forward the calls to:
 - To forward calls to the last number to which calls were forwarded, press the **Enable** soft key.
- OR
- To forward calls to a different number, press the **Edit** soft key and enter the number that you want to forward the calls to.
 - Press the **Save** soft key to save the new number.
 - Press the **Enable** soft key.

The screen displays `Forward>` and the number to which calls will be forwarded.

To activate call forwarding–busy:

Feature

1. Press the **Feature** soft key.

CFwd

2. Press the **CFwd** soft key.
 The screen displays `Call Forward?`

Yes

3. Press the **Yes** soft key.

Busy

4. Press the **Busy** soft key.
 The screen displays `Forward On Busy?`

5. Specify the number that you want to forward the calls to:

Enable

- To forward calls to the last number to which calls were forwarded, press the **Enable** soft key.

OR

Edit

Save

Enable

- To forward calls to a different number, press the **Edit** soft key and enter the number that you want to forward the calls to.
- Press the **Save** soft key to save the new number.
- Press the **Enable** soft key.

The screen displays `Forward>` and the number to which calls will be forwarded.

To cancel call forwarding

Feature

CFwd

Yes

Disable

1. Press the **Feature** soft key.
2. Press the soft key for whichever type of call forwarding is enabled:
 - **All**
 - **Busy**
 - **NoAns**

3. Press the **Yes** soft key.

The screen displays the last number to which calls were forwarded.

4. Press the **Disable** soft key.

The screen displays `Cancel forward>` to confirm the change.

Note: If the IP Deskphone is ringing or is in Do Not Disturb mode, you cannot forward the call.

Follow me

Follow me to is used to redirect your calls to another extension where you will be working. The calls are presented with your user name so that you can distinguish them from calls for the extension's assigned user. This allows you to share another person's phone without logging them off their phone.

When you enable Follow me, the screen on your phone displays a message to confirm that the feature is active, and indicates the extension where the calls are redirected to. On the phone to which your calls are redirected, the screen displays a message to confirm that the feature is active and receiving calls from your extension.

The redirected calls are subject to all of your user settings as if they were ringing at your phone. For example, if you do not answer the redirected call, or if the line is busy, the redirected call is treated like an unanswered call to your own extension.

Two options are available:

- Follow Me To—use this option to enable the feature from your own phone.
- Follow Me Here—use this option to enable the feature from the extension where you want to receive your calls.

To redirect calls using Follow Me To:

Feature

1. Press the **Feature** soft key.

FoIto

2. Press the **FoIto** soft key.

The screen displays Follow Me To?

Yes

3. Press the **Yes** softkey.

The screen displays the last number to which calls were redirected.

4. Specify the number that you want to redirect the calls to:

— To redirect calls to the same number, press the **Enable** soft key.

OR

— To redirect calls to a different number, press the **Edit** soft key and enter the number that you want to redirect the calls to.

— Press the **Done** soft key to save the new number.

— Press the **Enable** soft key.

Enable

Edit

Done

Enable

The screen displays `Activation OK..`

To redirect calls using Follow Me Here:

Feature

1. Press the **Feature** soft key.

Here+

2. Press the **Here+** soft key.

The screen displays `Follow Me Here?`

Yes

3. Press the **Yes** softkey.

The screen displays the last number to which calls were redirected.

4. Specify the number that you want to redirect the calls to:

— To redirect calls to the same number, press the **Enable** soft key.

OR

— To redirect calls to a different number, press the **Edit** soft key and enter the number that you want to redirect the calls to.

— Press the **Done** soft key to save the new number.

— Press the **Enable** soft key.

Enable

Edit

Done

Enable

The screen displays `Activation OK..`

To cancel Follow Me Here:

When you cancel Follow Me Here, you must do so from the same extension where you activated the feature and received the redirected calls.

Feature

1. Press the **Feature** soft key.

Here-

2. Press the **Here-** soft key.

The screen displays `Cancel Follow Me Here?`

Yes

Edit

Done

Enable

3. Press the **Yes** softkey.
4. Press the **Edit** soft key and at the prompt, enter your own extension number.
5. Press the **Done** soft key when you have finished entering your extension number.
6. Press the **Enable** soft key.
The screen displays `Activation OK`.

The Address Book

The Address Book is a personal directory of contacts from which you can make a phone call. You can access the Address Book while on a call and start a new call from the highlighted contact. You can use the Address Book for the following:

- “Viewing the Address Book” on page 159
- “Initiating a call from the Address Book” on page 160
- “Adding a contact to your Address Book” on page 162
- “Editing a contact in your Address Book” on page 163
- “Copying information to the Address Book” on page 167
- “Searching for a contact in the Address Book” on page 169

Viewing the Address Book

To access the Address Book, press the **Directory** fixed key or press the **View** context-sensitive soft key, and then select **Address Book** from the menu. See [Figure 18 on page 159](#).

Figure 18: The Address Book

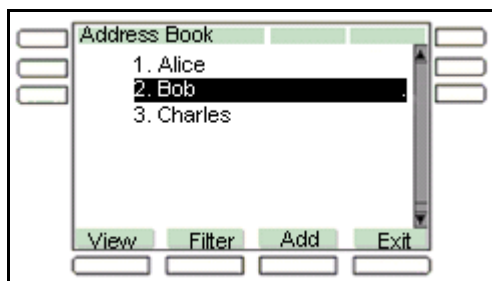

To view information about a contact use the navigation button to highlight a name, and then press the **View** context-sensitive soft key. See [Figure 19 on page 160](#).

When you view the details of a contact, you can:

- Edit the contact information. For more information, see [“Editing a contact in your Address Book” on page 163](#).

Figure 19: Contact details



Initiating a call from the Address Book

You can initiate a call directly from your IP Deskphone Address Book.

Note: If your service provider requires that a Directory Number (DN) be used to initiate a call, the Address Book entry must have the DN to initiate a call.

First, go off-hook by using one of the methods described in the section [“Making a call using off-hook dialing” on page 129](#). You can also access the Address Book while on an active call and initiate a new call. The IP Deskphone automatically places the active call on hold when you initiate a new call.

To initiate a call to a contact stored in the Address Book:



Directory

1. Press the **Directory** fixed key to select a contact from the Address Book to call.



View



2. Press the **Up/Down** navigation key to highlight a contact on the list.

3. Press the **View** context-sensitive soft key to make a call to the contact.

4. Choose one of the following:

- Press the **Call** context-sensitive soft key to make a call to the contact.
- Press the **Back** context-sensitive soft key to return to the off-hook screen.

Call



or

Back



Adding a contact to your Address Book

You can add a new contacts to the Address Book of the IP Deskphone.

To add a contact to your Address Book:



Add

abc



Next

Back



1. Choose one of the following:
 - Press the **Directory** fixed key.
 - Press the **Add** context-sensitive soft key, select **Address Book** from the menu, and then press the **New** context-sensitive soft key.
2. Press the **abc/123** context-sensitive soft key to toggle between alphabetic and numeric characters.
3. Choose one of the following:
 - Use the dialpad to enter a name for the new contact and press the **Next** context-sensitive soft key to continue.
 - Press the **Back** context-sensitive soft key to return to the previous menu.
4. Use the dialpad to enter a phone number or SIP address (URI) for the new contact.

Yes

No

Back

Ok

5. Do one of the following to complete the entry:
 - Press the **Yes** context-sensitive soft key to add the contact to a group and then select the group for the contact to be added.
 - Press the **No** context-sensitive soft key if you do not want to add the contact to a group, and return to the address menu screen.
 - Press the **Back** context-sensitive soft key to return to the previous menu.

6. Press the **Ok** context-sensitive soft key to complete the entry and return to the Address Book menu.

Editing a contact in your Address Book

You can edit a contact in your Address Book.

To edit a contact in your Address Book:



Directory

1. Press the **Directory** fixed key.



View



Edit



abc



Next



Back



2. Press the **Up/Down** navigation key to highlight the contact you want to edit, and then press the **View** context-sensitive soft key.
3. Press the **Edit** context-sensitive soft key to edit the contact information.
4. Press the **abc/123** context-sensitive soft key to toggle between alphabetic and numeric characters.
5. Use the dialpad to enter the new name for the contact.
6. Choose one of the following:
 - Press the **Next** context-sensitive soft key to continue.
 - Press the **Back** context-sensitive soft key to return to the previous menu.

Note: If you only need to change the SIP address or phone number for the contact, press the **Next** context-sensitive soft key without making changes to the name.



Next

Back

Yes

No

Back

7. Use the dialpad to enter a new phone number or new SIP address (URI) for the contact.

8. Choose one of the following:

- Press the **Next** context-sensitive soft key to continue.
- Press the **Back** context-sensitive soft key to return to the previous menu.

9. Do one of the following to complete the entry:

- Press the **Yes** context-sensitive soft key to designate the contact as a friend and return to the address menu screen.
- Press the **No** context-sensitive soft key if you do not want a contact designated as a friend and return to the address menu screen.

Note: If the contact is already designated as a friend then the question *Remove from friends?* appears. Press the **Yes** context-sensitive soft key to remove the contact from your friends list or press the **No** context-sensitive soft key to keep the contact on your friends list.

- Press the **Back** context-sensitive soft key to return to the previous menu.

Ok



10. Press the **Ok** context-sensitive soft key to complete the entry and return to the previous menu.

To delete a contact from your Address Book:



View



1. Press the **Up/Down** navigation key to highlight the contact you want to delete and press the **View** context-sensitive soft key.

Edit



2. Press the **Edit** context-sensitive soft key to access the contact information.

Delete



3. Press the **Delete** context-sensitive soft key to completely delete the contact from the Address Book.

Ok



4. Choose one of the following:

- Press the **Ok** context-sensitive soft key to confirm.
- Press the **Back** context-sensitive soft key to return to the previous menu.

Back

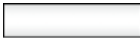

Ok



5. Press the **Ok** context-sensitive soft key to complete the procedure and return to the Address Book.

Copying information to the Address Book

To copy information from the Call Inbox or the **Call Outbox** screen to the Address Book use the **Copy** fixed key.

Note: If you press the **Copy** fixed key while in idle mode the message, No content selected for copying appears on the screen.

To copy a contact to the Address Book:



1. Press the **Up/Down** navigation key to highlight the contact in the Call Inbox or Call Outbox that you want to add to your Address Book and press the **Copy** fixed key.



A new screen appears offering the following destinations for the contact information:

- 1. Address Book



Select



2. Press the **Up/Down** navigation key to highlight the Address Book and press the **Select** context-sensitive soft key.

abc



3. Press the **abc/123** context-sensitive soft key to toggle between alphabetic and numeric characters.



Next

Back

4. Use the dialpad to enter a name for the new entry.

5. Choose one of the following:

- Press the **Next** context-sensitive soft key to continue.
- Press the **Back** context-sensitive soft key to return to the previous menu.

Note: If you do not need to change the name for the contact, press the **Next** context-sensitive soft key.



Next

Back

6. Use the dialpad to enter a new phone number or new SIP address for the contact.

7. Choose one of the following:

- Press the **Next** context-sensitive soft key to continue.
- Press the **Back** context-sensitive soft key to return to the previous menu.

Note: If you do not need to change the name for the contact, press the **Next** context-sensitive soft key.

8. Do one of the following to complete the entry:

Yes

No

Back

- Press the **Yes** context-sensitive soft key to add the contact to a group and then select the group for the contact to be added.
- Press the **No** context-sensitive soft key if you do not want a contact designated as a friend and return to the address menu screen.
- Press the **Back** context-sensitive soft key to return to the previous menu.

9. Choose one of the following:

Yes

No

- Press the **Yes** context-sensitive soft key to designate the contact as a friend.
- Press the **No** context-sensitive soft key if you do not want to designate the contact as a friend and return to the address menu screen.

Ok

10. Press the **Ok** context-sensitive soft key to complete the entry and return to the previous menu.

Searching for a contact in the Address Book

When you access the IP Deskphone Address Book you can perform a search for a contact using one of the following methods:

- Index Search (performs a search based on the index number you enter)

- 1st Character Search (performs a search based on the first character you enter)
- Name Search (performs a search based on the name you enter)

To change the method the IP Deskphone uses to search.

Prefs



1. Press the **Prefs** context-sensitive soft key, select **Misc Options**, and then highlight **Search Method** from the menu.

Change



2. Press the **Change** context-sensitive soft key.



3. Press the **Up/Down** navigation key to highlight the Search Method you want to use as the default when you search for a contact:

- 1. Index Search
- 2. 1st Character Search
- 3. Name Search

Select



4. Press the **Select** context-sensitive soft key to select a search method, and then return to the previous menu.

Using the Search feature in the Address Book

To search for a contact while accessing your personal Address Book, use the dialpad to enter the search information. For example:

- Index Search—to search for a contact by using the Index Search method, enter the index number. When entering an index number larger than 9, you must enter the next digit quickly to move to that item on the list. For example, if the address you need is item 28 on the list, you must enter the digit 8 quickly after entering the digit 2.

- **1st Character Search**—to search for a contact whose name begins with the letter *d*, using the dialpad, press the *d* (3) key on the dialpad. The first entry in the Address Book that begins with the letter *d* appears.
- **Name Search**—to search for a specific name in your personal Address Book, enter the name by using the dialpad.

Using the Search feature

You can search for a contact that is in your IP Deskphone Address Book . You can save a contact name and SIP address found on the call server to your personal Address Book stored in your IP Deskphone.

Using Local Search

You can search for a contact that is stored in your Address Book.

To search for a contact stored in your Address Book:



Services

1. Press the **Services** fixed key, select **Search**, and then select **Local Search** from the menu.



Select



2. Press the **Up/Down** navigation key and then press the **Select** context-sensitive soft key to choose a search criteria:
 - 1. User Name
 - 2. Name
 - 3. Phone Number

abc



Search



Back



Call



Search



Exit



3. Press the **abc/123** context-sensitive soft key to toggle between alphabetic and numeric characters.

4. Use the dialpad to enter the search information for the contact.

5. Choose one of the following:

- Press the **Search** context-sensitive soft key.
- Press the **Back** context-sensitive soft key to return to the previous menu.

Note: When the search is unsuccessful, the following message appears:

No entries found for <search criteria>

6. When a search result is successful, you can do one of the following:

- Press the **Up/Down** navigation key to highlight a contact, from the search result and press the **Call** context-sensitive soft key to initiate a call.
- Press the **Search** context-sensitive soft key to start a new search.
- Press the **Exit** context-sensitive soft key to return to the idle screen.

Search



Exit



7. When a search result is not successful, you can do one of the following:
 - Press the **Search** context-sensitive soft key to return to the search menu and begin a new search.
 - Press the **Exit** context-sensitive soft key to return to the idle screen.

Call Inbox

While your IP Deskphone is active, all incoming calls are saved in your Call Inbox. You can view the following details about each call:

- Call status (Missed)
- Name of the caller
- SIP address
- Time of the call
- Number of consecutive calls each caller made to you

You can set the filter on your Call Inbox to display all incoming calls or missed calls. You can access your Call Inbox while the IP Deskphone is idle or while you are on a call.

Accessing the Call Inbox

You can access the Call Inbox and initiate a call when the IP Deskphone is:

- Idle. For more information, see [“Managing calls in the Call Inbox while not on a call” on page 174.](#)
- Active. For more information, see [“Accessing the calls in your Call Inbox during a call” on page 183.](#)

Managing calls in the Call Inbox while not on a call

You can manage calls in the Call Inbox while you are not on a call.

To manage calls in the Call Inbox while not on a call:



1. Press the **Msg/Inbox** fixed key.



2. Press the **Up/Down** navigation key to highlight a call from the list of calls in your Call Inbox.

Note: You can initiate a call to the highlighted caller. For more information, see [“Initiating a call from the Call Inbox” on page 181.](#)

Enter



3. Do one of the following:

- To place a call to the selected address using the primary login of the IP Deskphone, press the **Enter** key.
- To view the details of a highlighted call, press the **Right** navigation key. See [“Viewing the details of a call in the Call Inbox” on page 177.](#)
- To leave the detail view and return to the main inbox screen, press the **Left** navigation key.
- Press the **Missed** context-sensitive soft key to toggle the view filter from the **All** context-sensitive soft key to the **Missed** context-sensitive soft key. See [“Managing missed calls” on page 178.](#)



Missed



All



- The **All** context-sensitive soft key is displayed when the view mode is on **Missed**, and displays all the calls in the Call Inbox.

Delete



- Press the **Delete** context-sensitive soft key to delete the highlighted call or all calls in your Call Inbox. See [“Deleting calls in your Call Inbox” on page 183](#).

Exit



- Press the **Exit** context-sensitive soft key to exit the Call Inbox.

Table 16 on page 176 provides a list of additional user interactions for the main inbox screen.

Table 16: Additional user interactions





| Item | Function |
|---|--|
|  | <p>Use the Enter key to place a call to the selected address using the primary login of the IP Deskphone.</p> <p>The Enter key has the same behavior as the Call context-sensitive soft key.</p> |
|  | <p>Use the Dial pad to select an item by index.</p> |
|  | <p>To place a call to the address of the selected call log entry from the primary logged in user of the IP Deskphone, do one of the following:</p> <ul style="list-style-type: none"> — Lift the handset. — Press the Headset fixed key. — Press the Handsfree fixed key. |

Table 16: Additional user interactions

| Item | Function |
|---|---|
|  | Press the Line key to place a call to the address of the selected call log entry from the user logged in on the selected line key. |

Viewing the details of a call in the Call Inbox

You can view the details of a call in the Call Inbox.

To view details of a call in the Call Inbox:

- When you view the details of a call in the Call Inbox, you can do the following:
 - Initiate a call to the caller displayed on the screen. For more information, see [“Initiating a call from the Call Inbox” on page 181](#).
 - Press the **Enter** context-sensitive soft key to place a call to the selected address using the primary login of the IP Deskphone.
 - Press the **Prev** context-sensitive soft key to select and display the details of the previous entry in the call log.
 - Press the **Next** context-sensitive soft key to select and display the details of the next entry in the call log.
 - Press the **Back** context-sensitive soft key to leave the detail view and return to the main inbox screen.

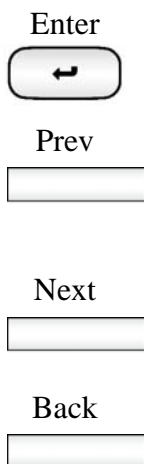

Managing missed calls

When you do not answer incoming calls, the number of new calls appears on the IP Deskphone LCD screen. For example, if you miss three calls the following message appears: 3 new calls.

Note: When you view a missed call in your Call Inbox, the new call message no longer appears on the LCD screen. The new calls are stored as missed calls.

To view missed calls:

Msg/Inbox



1. Press the **Msg/Inbox** fixed key and then press the **Missed** context-sensitive soft key.



2. Press the **Up/Down** navigation key to highlight a call from the list of missed calls.



3. Press the **Right** context-sensitive soft key to view the details of the missed call.

Note: You manage the missed call the same as any call that is in your Call Inbox. For more information, see [“Viewing the details of a call in the Call Inbox” on page 177](#) and [“Initiating a call from the Call Inbox” on page 181](#).

All



4. To view all the calls in the Call Inbox, press the **All** context-sensitive soft key.

Delete



- To delete the highlighted missed call or all missed calls, press the **Delete** context-sensitive soft key. For more information, see “[Deleting calls in your Call Inbox](#)” on page 183.

Note: The IP Deskphone deletes only the missed calls from the Call Inbox.

Exit



- To exit the Inbox and return to the idle IP Deskphone screen, press the **Exit** context-sensitive soft key.

Missed Calls Notification

You can change the call log behavior so that the message `xx new calls` is cleared by entering the Inbox without having to select each missed call.

Changing the Missed Calls Notification behavior:

Msgs



- Press the **Msgs** context-sensitive soft key.



- Press the **Up/Down** navigation key to highlight **Missed Calls Notification**.

Select



3. Choose one of the following:

- Press the **Select** context-sensitive soft key.
- Press the **Back** context-sensitive soft key to abort the changing of the configurations and return to the Message Options screen.

If you press the **Select** context-sensitive soft key, one of the following messages appears (based on the current setting of the option):

- Press Manual to change Missed Call Notification Message clearing mode
- Press Auto to change Missed Call Notification Message clearing mode

Auto



4. Choose one of the following:

- Press the **Auto** context-sensitive soft key to change the clearing mode for the `xx new calls missed call` message for the IP Deskphone.

Note: **Auto** means that the message is cleared from the idle screen as soon as you enter the Inbox.

Manual



- Press the **Manual** context-sensitive soft key to change the clearing mode for the `xx new calls missed call` message for the IP Deskphone.

Note: **Manual** means that the message is cleared from the idle screen only after you look at the call detail for every newly missed call in the Inbox.

Initiating a call from the Call Inbox

When you receive a call that is missed or answered, the calling number is listed in the Inbox. You can select the number, and then dial from the Inbox, or you can edit the number in the Inbox.

To initiate a call from the Call Inbox, press the **Msg/Inbox** fixed key and select **Inbox** from the menu.

Note 1: If your service provider requires that a Directory Number (DN) be used to initiate a call, the Call Inbox entry must have the DN to initiate a call.

Note 2: While you are on a call, you can initiate a new call from the Call Inbox. For more information, see [“Accessing the calls in your Call Inbox during a call” on page 183](#).

To initiate a call from the Call Inbox:



Msg/Inbox

1. Press the **Msg/Inbox** fixed key.



2. Press the **Up/Down** navigation key to highlight a call from the list of calls in your Call Inbox.



3. To view details of the call, press the **Right** navigation key.



Edit



Call



4. To place a call to the selected address, do one of the following:

- Lift the handset.
- Press the **Headset** fixed key.
- Press the **Handsfree** fixed key.

or

Press the **Edit** context-sensitive soft key

Then press the **Send** context-sensitive soft key.

Deleting calls in your Call Inbox

When you delete calls from the Call Inbox, both missed calls and answered calls are deleted. When you view the missed calls and select delete, only the missed calls are deleted.

To delete calls from your Call Inbox:



Delete



Yes



AllUsr



All



No



1. Press the **Up/Down** navigation key to highlight a call from the list of calls in your Call Inbox.
2. Press the **Delete** context-sensitive soft key.
3. Select one of the following context-sensitive soft keys:
 - Press the **Yes** context-sensitive soft key to delete the highlighted call.
 - Press the **AllUsr** context-sensitive soft key to delete all the calls from the selected caller.
 - Press the **All** context-sensitive soft key to clear all calls from the Call Inbox.
 - Press the **No** context-sensitive soft key to return to the Inbox.

Accessing the calls in your Call Inbox during a call

You can access the calls in your Call Inbox while you are in an active call.

To access the calls in your Call Inbox during a call:



Select



Back



1. Press the **Up/Down** navigation key to highlight a call from the list of calls in your Call Inbox.
2. Choose one of the following:
 - Press the **Select** context-sensitive soft key to initiate a call to the highlighted caller.
Note: This places the current call on hold, if it is not already on hold.
 - Press the **Back** context-sensitive soft key to return to the in-call screen.

Call Outbox

The Call Outbox keeps a record of all outgoing calls made from your Avaya 1140E IP Deskphone. You can add the contact details of the calls in your outbox to your Address Book. You can access the following details about the outgoing calls:

- Name
- Address
- Time of the call
- Number of Calls

Accessing the Call Outbox

You can access the Call Outbox and initiate a call when the IP Deskphone is:

- Idle. For more information, see [“Initiating a call from the Call Outbox” on page 187](#).
- Active. For more information, see [“Accessing the calls in your Call Outbox during a call” on page 190](#).

Managing calls in the Call Outbox while not on a call

You can manage calls in the Call Outbox while you are not in an active call.

To manage calls in the Call Outbox while not on a call:



Shift/Outbox

1. Press the **Outbox** fixed key.



2. Press the **Up/Down** navigation key to highlight a call from the list of calls in your Call Outbox.



3. Choose one of the following:
 - To view details of the selected call, press the **Right** navigation key. See [“Viewing the details of a call in the Call Inbox” on page 177](#).
 - To leave the detail view and return to the main inbox screen, press the **Left** navigation key.

Delete



Exit



4. Press the **Delete** context-sensitive soft key to delete the highlighted call. For more information, see [“Deleting calls from your Call Outbox”](#) on page 188.
5. Press the **Exit** context-sensitive soft key to return to the idle screen.

Initiating a call from the Call Outbox

Note: If your service provider requires that a Directory Number (DN) be used to initiate a call, the Call Outbox entry must have a DN to initiate a call.

To initiate a call from the Call Outbox:



Shift/Outbox

1. Press the **Outbox** fixed key.



2. Press the **Up/Down** navigation key to highlight a call from the list of calls in your Call Outbox.



3. To view details of the selected call, press the **Right** navigation key. See [“Viewing the details of a call in the Call Outbox”](#) on page 189.

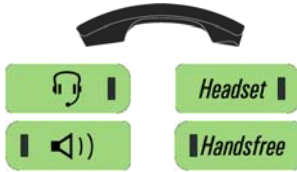

Call



4. You can initiate a call from the highlighted call of the Call Outbox list or from the details of a caller screen, by doing one of the following:

- Lift the handset.
- Press the **Headset** fixed key.
- Press the **Handsfree** fixed key.

5. Press the **Call** context-sensitive soft key.

Deleting calls from your Call Outbox

You can delete calls from your Call Outbox.

To delete calls from your Call Outbox:



Delete



1. Press the **Up/Down** navigation key to highlight a call from the list of calls in your Call Outbox.
2. Press the **Delete** context-sensitive soft key.

Yes

AllUsr

All

No

3. Select one of the following context-sensitive soft keys:

- Press the **Yes** context-sensitive soft key to delete the highlighted call.
- Press the **AllUsr** context-sensitive soft key to delete all the calls from the selected caller.
- Press the **All** context-sensitive soft key to clear all calls from the Call Outbox.
- Press the **No** context-sensitive soft key to return to the Outbox.

Viewing the details of a call in the Call Outbox

You can view details of a call in the Call Outbox.

To view details of a call in the Call Outbox:



Call



Prev



Next



Back



1. To view details of the selected call, press the **Right** navigation key
2. When you view the details of a call in the Call Outbox you can do one of the following:
 - Initiate a call to the caller displayed on the screen. See [“To initiate a call from the Call Outbox:”](#) on page 187.
 - View a previous caller in the Call Outbox list by pressing the **Prev** context-sensitive soft key and return to the **Outbox** screen.
 - View the next caller in the Call Outbox list by pressing the **Next** context-sensitive soft key and return to the **Outbox** screen.
 - Press the **Back** context-sensitive soft key to return to the Outbox.

Accessing the calls in your Call Outbox during a call

You can access the calls in your Call Outbox during an active call.

To access the calls in your Call Outbox during a call:



Shift/Outbox

1. To access the calls in your Call Outbox during a call, press the **Call Outbox** key



2. Press the **Up/Down** navigation key to highlight a call from the list of calls in your Call Outbox.

Select



Back



3. Choose one of the following:
 - Press the **Select** context-sensitive soft key to initiate a call to the highlighted caller.

Note: This places the current call on hold, if it is not already on hold.

- Press the **Back** context-sensitive soft key to return to the **Incall** screen.

While on an active call

You can use the following features during an active call:

- “Making a new call” on page 192
- “Call Waiting” on page 193
- “Placing a call On Hold” on page 194
- “Using call conferencing” on page 201
- “Transferring a call” on page 202
- “Using the Call Park feature” on page 205
- “Using account codes” on page 207
- “Recording a call” on page 208

You can use the **Action** context-sensitive soft key to perform the following actions with an active call:

1. New Call—to begin a new call while other calls are on hold.
2. Transfer Call—to transfer the call to another phone number or SIP address.

Making a new call

You can initiate a new call during a current call. If you do not place the current call on hold first, the IP Deskphone automatically places the current call on hold when you initiate a new call. You can initiate a new call by using any of the following methods:

- “Initiating a call using the active call context-sensitive soft key menu” on page 193
- “Initiating a call from the Address Book” on page 160
- “Initiating a call from the Call Inbox” on page 181
- “Initiating a call from the Call Outbox” on page 187

Initiating a call using the active call context-sensitive soft key menu

You can initiate a call using the active call context-sensitive soft key menu.

To initiate a call using the active call context-sensitive soft key menu:

More...



NewCall



Back



1. Choose one of the following:

- While on a call, press the **More...** context-sensitive soft key, and then the **NewCall** context-sensitive soft key.

The IP Deskphone produces a dial tone.

2. Choose one of the following:

- Use the dial pad to dial the number or SIP address.

Note: This places the current call on hold, if it is not already on hold, and you can continue to initiate the call as normally.

- Press the **Back** context-sensitive soft key to return to the in-call screen.

Call Waiting

While you are on an active call and you receive an incoming call. You are notified of an incoming call by a message on the LCD screen and a notifying beep. Answering the new call places the active call on hold you can also redirect the new call, transfer the new call, or ignore the new call. For more information, see [“Receiving a call” on page 139](#).

Placing a call On Hold

Use the Hold feature when you are talking to one contact and want to perform another action, such as answer a new incoming call, transfer a call, or initiate a new call. You can have a number of calls on hold at the same time.

To place a call on hold:



1. Press the **Hold** fixed key.

The LCD on hold icon flashes beside the line on hold.

To retrieve a call on hold:

chad



1. To retrieve a call on hold do one of the following:

- Press the **Line** feature key beside the flashing LCD indicator.
- Press the **Hold** fixed key.



Multiple calls On Hold

When you have more than one call on hold, use the navigation key to highlight a call on the LCD screen. You can perform an action with that call by using the context-sensitive soft keys on the In-call menu list. The context-sensitive soft keys displayed vary depending on the type of call that is currently selected. For example, a held call has the **Activate** context-sensitive soft key instead of the **Audio** context-sensitive soft key.

When you highlight a call that is not active, you can retrieve the call from on hold and make it active by pressing the **Activate** context-sensitive soft key. You can also join the call with the active call to create a conference calling session. See [“Using call conferencing” on page 201](#).

Multiple calls In-call mode

When the IP Deskphone has multiple calls connected at the same time, you can access the menu items.

Context-sensitive soft keys for the multiple calls In-call display screen

NewCall



Press **NewCall** context-sensitive soft key to obtain a dial tone to place another call. The **NewCall** context-sensitive soft key is used to make a conference call. This key behaves like the **Conf** context-sensitive soft key.

Audio/Activate



Press the **Audio** context-sensitive soft key to change the audio settings or the current active call.

The **Activate** context-sensitive soft key appears when the highlighted call is not the selected call.

Press the **Activate** context-sensitive soft key to place the current call on hold and activate the call you want to connect to.

This context-sensitive soft key is also used to retrieve calls parked against the user.

Note: The **Activate** context-sensitive soft key never appears at the same time as the **Audio** context-sensitive soft key

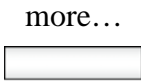

Press the **more...** context-sensitive soft key to select a new menu list of context-sensitive soft keys.

When you press the **more...** context-sensitive soft key, a different selection of context-sensitive soft keys appears.

- If you press the **more...** context-sensitive soft key once from the first menu list, you access the following context-sensitive soft keys:

[Trnsfer] [more...]

- If you press the **more...** context-sensitive soft key from the first menu list twice, you access the following context-sensitive soft keys:

[Prefs] [more...]

- If you press the **more...** context-sensitive soft key from the first menu list three times, you return to the first menu list with the following context-sensitive soft keys.

[NewCall] [Audio] [more...]

When you press the **more...** context-sensitive soft key for the first time, the following context-sensitive soft keys appear on the menu list.



Press the **Trnsfer** context-sensitive soft key to transfer the current call.

more...



Press the **more...** context-sensitive soft key to select a new menu list of context-sensitive soft keys.

The next available menu list contains the following context-sensitive soft keys:

[Retrve] [Prefs] [more...]

When you press the **more...** context-sensitive soft key for the second time, the following context-sensitive soft keys appear on the menu list.

Prefs



Press the **Prefs** context-sensitive soft key to display the Preferences menu.

The menu items include the following:

1. Display—use to adjust the display settings of the LCD screen.
2. Audio—use to adjust tones and volume settings, to configure a USB headset, and to access the Bluetooth wireless technology setup.
3. Feature Options—use to configure the following:
 - Programmable keys
 - Call Ignore Action
 - Call Fwd Notification
 - Answer Mode Settings appear when the Auto Answer Mode is enabled on the IP Deskphone.
4. Language—use to change the interface language.
5. Misc Options—use to access the following options:
 - Alpha Dialing
 - Search Method
 - Incoming Privacy
 - Outgoing Privacy
 - Hold Mode: Private
 - Time

Prefs



6. Network—use to access the following:
 - Server Settings
 - Device Settings
 - Diagnostics
 - Disable screensaver
 - Licensing
 - Lock
7. USB Locks—use to lock or unlock the following USB devices:
 - USB Mouse
 - USB Keyboard
 - USB Headset
 - USB flash drive
8. User Settings—use to modify the following:
 - Call Settings

more...



Press the **more...** context-sensitive soft key to return to the first menu list of context-sensitive soft keys.

The next available menu list contains the following context-sensitive soft keys:

[NewCall] [Audio] [more...]

To access a call on hold when multiple calls are on hold:



1. Press the **Up/Down** navigation key to highlight a call on hold.

Chad



2. To retrieve the highlighted call on hold do one of the following:

- Press the **Line** feature key beside the flashing LCD indicator.
- Press the **Hold** fixed key to retrieve a call on hold.



To make a call on hold the active call:



1. Press the **Up/Down** navigation key to highlight a call on hold.

Activate



2. Press the **Activate** context-sensitive soft key to make the highlighted call on hold the active call.

This removes the call from on hold and automatically places the previous call on hold.

Using call conferencing

You can use the Conference feature to establish a conference call between the active call and calls on hold. The Conference feature is available when you are on an active call.

To use call conferencing:



1. Enter the first phone number or SIP address that you want to call.



2. Place the active call on hold.



3. Make a second call.

4. When the second call is connected, choose one of the following methods to establish a conference call:

Conf



- Press the **Conf** soft key and then press the line button of the first held call.

OR

Feature



- Press the **Feature** soft key.



- Enter **3** on the keypad.



- Press the **Enter** button.



- Press the Line button of the first held call.

Transferring a call

Note 1: When more than one call is on hold, the call you want to transfer must be the active call. For more information, see [“To make a call on hold the active call:” on page 200.](#)

Note 2: The IP Deskphone does not automatically place the call you want to transfer on hold. To prevent the caller from hearing the transfer process, place the caller on hold and then complete the transfer process.

To transfer a call to another IP Deskphone:



1. Press the **Up/Down** navigation key to highlight Transfer Call from the menu.

Transfer

abc



Select

Transfr

Clear

Back

2. Press the **Transfer** context-sensitive soft key while on a call to access the **Transfer** menu.
3. Press the **abc/123** context-sensitive soft key to toggle between numeric and alphabetic input.
4. Choose one of the following:
 - Enter the phone number or SIP address to which you are transferring the call.
 - Select a contact from the Address Book, Call Inbox, or Call Outbox by pressing the corresponding fixed key.
Highlight a contact from the list and then press the **Select** context-sensitive soft key.
5. Choose one of the following:
 - Press the **Transfr** context-sensitive soft key to connect the calling party.
 - To erase the address you enter, press the **Clear** context-sensitive soft key.
 - To return to the previous screen, press the **Back** context-sensitive soft key.

The IP Deskphone prompts you with the following question, Consult with party?

Yes

No

Back

6. Select one of the following context-sensitive soft keys:

- Press the **Yes** context-sensitive soft key to consult with the contact to which you are transferring the call before completing the transfer.
- Press the **No** context-sensitive soft key to transfer the call without consulting the contact to whom you want to transfer the call.
- Press the **Back** context-sensitive soft key to return to the previous screen.

Using the Call Park feature

You can use the Call Park feature to temporarily park a call so that you or another user can retrieve the parked call from another phone. Using Call Park does not tie up a line, because the call is held on the IP Office call server.

A timer determines how long a call can remain parked; this timer is configured by your system administrator. If the timer expires before the call is retrieved at another extension, the call is returned to your phone.

To park a call:

Feature

1. Press the **Feature** soft key.

CPark

2. Press the **CPark** soft key.

The screen displays the message Call Park?

Yes

3. Press the **Yes** soft key.

The deskphone displays the following prompt: PrkOn:>



4. Using the key pad, enter an ID for the parked call. Enter an ID that is up to 9 digits in length. You will need to enter this ID when you retrieve the call from park.

Note: If there is not currently an active called parked that uses the ID that you have entered, the deskphone displays Forbidden.

Ok



5. Press the **OK** soft key.

The screen displays `To:CPark
<extension number@IPaddress>`.

Retrieving a Parked Call

You must have the retrieval code to retrieve a parked call from the server. You can retrieve a parked call while the IP Deskphone is in the idle state or while on a call.

To retrieve a parked call

Feature



1. Press the **Feature** soft key.

RCall



2. Press the **RCall** soft key.

The screen displays `Retrieve?`

Yes



3. Press the **Yes** soft key.

The deskphone displays the following prompt: `UnPark:>`



4. Using the key pad, enter the ID for the parked call.

Ok

5. Press the **OK** soft key.

Note: If there is not currently an active call parked that uses the ID that you have entered, the deskphone displays Forbidden.

Using account codes

Your system administrator can configure account codes on the IP Office call server. Account codes can be used to keep track of calls in relation to particular activities or clients. They can also be used to keep track of calls by particular users or sets of users.

If your system uses account codes, you can enter an account code when you make a call, or during a call. The account code that you enter must match an account code set on the telephone system. If you enter an invalid code, the deskphone prompts you to re-enter the account code.

To use an account code:

Feature

1. Press the **Feature** soft key.

Acct

2. Press the **Acct** soft key.

The screen displays Account Code?

Yes

3. Press the **Yes** soft key.

The deskphone displays the prompt Enter Account>.



Ok



- Using the key pad, enter the account code for the call.
- Press the **Done** soft key.

Recording a call

The IP Deskphone allows you to record all or part of a conversation.

To record a call:

Feature



- Press the **Feature** soft key.

CRec



- Press the **CRec** soft key.

The screen displays `Call Record?`

Yes



- Press the **Yes** soft key.

The deskphone displays the message `Recording Started`.

An audio announcement plays to alert call participants that the call is being recorded.

To stop recording a call:

Feature



1. Press the **Feature** soft key.

CRec



2. Press the **CRec** soft key.

The screen displays Call Record?

Yes



3. Press the **Yes** soft key.

The deskphone displays the message
Recording Stopped.

Configuring custom settings

You can use the following additional features:

- “Programmable keys” on page 210
- “Assigning features to programmable keys” on page 212
- “Erasing a programmable key” on page 213
- “Restoring the default settings for programmable keys” on page 214
- “Configuring speed dial keys” on page 215
- “Querying programmable keys” on page 216
- “Using the relay option” on page 217
- “Twinning” on page 220
- “Configuring Privacy settings” on page 221
- “Audio Codecs” on page 223
- “Automatic remote firmware updates” on page 225
- “Screensaver/screen lock” on page 225
- “Background image” on page 230
- “USB flash memory device support” on page 230

Programmable keys

You can configure the programmable keys on the IP Deskphone or on a Key Expansion Module (KEM) to activate specific features. When you configure a programmable key, it acts as a short cut so that you do not need to enter a feature codes in order to activate the feature.

If a feature is programmed on a button, the status of the button will be updated with an active/idle state, depending of the status of that feature. This is supported by the following features:

- Call Forward All
- Twinning

- Private Call
- Automatic Callback
- Do Not Disturb
- Voicemail On
- After Call Work
- Call Record
- Follow Me Here
- Follow Me To

The IP Deskphone numbers the programmable keys on the IP Deskphone from 1 to 4. Key 1 is reserved as the line key for the IP Deskphone.

[Figure 20 on page 211](#) shows the Feature keys.



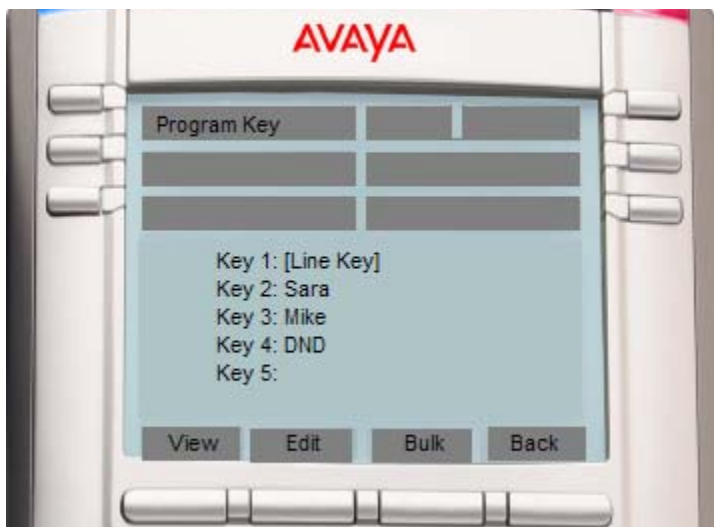

Figure 20: Feature keys



Assigning features to programmable keys

You can assign features to programmable keys in order to quickly activate features that you use frequently. Use the following procedure to assign a feature to a programmable key, or to change a feature that is already assigned.

To assign or change a feature:

- | | |
|--|---|
| <p>Feature</p>  | 1. Press the Feature soft key. |
| <p>BtnPg</p>  | 2. Press the BtnPg soft key. The screen displays the prompt <code>Button Programming?</code> |
| <p>Yes</p>  | 3. Press the Yes soft key. The <code>Button Programming</code> screen displays and prompts you to <code>Select a button</code> . |
|  | 4. Press the programmable key that you want to assign a feature to. If the key was not previously programmed, the screen prompts you to <code>Select feature</code> . If the key was already programmed, the screen displays options to <code>Erase</code> or <code>Edit</code> and prompts you to select one. |

Edit

- Choose one of the following options:
 - If the screen prompts you to **Select feature**, select a feature using the soft keys.
 - If the screen displays the options to **Erase** or **Edit**, press the **Edit** soft key. When the screen prompts you to, select a feature using the soft keys.

The screen displays the following options: **Quit**, **No**, or **Yes**.

Yes

- Press the **Yes** soft key.

The screen displays **Button Programmed** and a label displays next to the programmable key to indicate the name of the assigned feature.

Erasing a programmable key

To remove a feature from a programmable key:

Feature

- Press the **Feature** soft key.

BtnPg

- Press the **BtnPg** soft key.

The **Button Programming** screen displays and prompts you to **Select a button**.



3. Press the programmable key from which you want to delete the feature.

The screen displays options to `Erase` or `Edit` and prompts you to select one.

Erase



4. Press the **Erase** soft key.

The screen prompts you to `Select a feature` and then prompts you to confirm that you want to delete the selected item.

Yes



5. Press the **Yes** soft key.

The screen displays `Button Erased`.

Restoring the default settings for programmable keys

If you have assigned features to programmable keys, you can return the programmable keys to their default settings using the following procedure.

Restoring default settings:

Feature



1. Press the **Feature** soft key.

BtnPg



2. Press the **BtnPg** soft key.



3. Press the **Enter** key.

The screen prompts you to Select a button.

Reset



4. Press the **Reset** soft key.

The screen displays the message Reset to default?

Yes



5. Press the **Yes** soft key.

The screen displays Buttons Reset.

Configuring speed dial keys

You can configure the programmable keys for speed dialing.

To configure speed dialing:

Feature



1. Press the **Feature** soft key.



2. Enter ***1** or ***2** on the dialpad.



3. Press the **Enter** key.

The Speed Dial screen displays and prompts you to Press a button.



4. Press the programmable key that you want to assign a feature to.

The screen prompts you to enter a phone number.



5. Enter a phone number using the keypad.

OK



6. Press the **Ok** softkey.

Note: The screen prompts you to enter a label. Enter a label using the keypad, or press the Enter key to use the phone number as the label.



7. Press the **Enter** key.

The screen displays 'Programmed' and a label displays next to the programmable key to indicate the name of the assigned feature.

Querying programmable keys

You can query any of the programmable keys to confirm which function has been assigned to the key.

To query button programming:

Feature

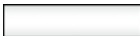

1. Press the **Feature** soft key.

BtnQy



2. Press the **BtnQy** soft key.

The **Button Inquiry** screen displays for 3 seconds and prompts you to press a button.



3. Press the programmable key that you want to query.

The screen displays text to indicate the name of the assigned feature for 3 seconds and prompts you to press a button for another query.

Exit



4. When you are finished querying programmable buttons, press the **Exit** soft key.

Using the relay option

You can use your IP Deskphone to activate external devices that are connected to the IP Office server through a relay connection. For example, you can use your IP Deskphone to activate a door release system.

The controls on your IP Deskphone allow you to close the relay switch the to activate the device; in this case, the device remains active until you open the relay switch to turn it off. Alternately, you can use relay pulse to activate the device for a 5 seconds.

To close the switch and activate a relay connection:

Feature



1. Press the **Feature** soft key.

Rely+

2. Press the **Rely+** soft key.

The screen displays Relay On?

Yes

3. Press the **Yes** soft key.

The screen displays the prompt Enter relay port.



4. Enter the number of the relay port that you want to activate: the options are 1 or 2.

Done

5. Press the **Done** soft key.

The screen display a confirmation message: Relay_On: Port<#>.

To open the switch and de-activate a relay connection:

Feature

1. Press the **Feature** soft key.

Rely+

2. Press the **Rely+** soft key.

Yes

3. Press the **Yes** soft key.

The screen displays the prompt Enter relay port.



Done



4. Enter the number of the relay port that you want to de-activate: the options are 1 or 2.

5. Press the **Done** soft key.

The screen display a confirmation message: Relay_Off: Port<#>.

To use relay pulse:

Feature



1. Press the **Feature** soft key.

Relay



2. Press the **Relay** soft key.

The screen displays Relay Pulse?

Yes



3. Press the **Yes** soft key.

The screen displays the prompt Enter relay port.



Done



4. Enter the number of the relay port that you want to activate: the options are 1 or 2.

5. Press the **Done** soft key.

The screen display a confirmation message: Relay Pulse: Port<#>.

Twining

Twining is a feature that allows you to have your calls ring on two phones. You can twin your IP Deskphone with another internal phone, or with an external phone. For example, you can twin your IP Deskphone with a mobile phone. Your incoming calls will ring on both phones. You can also make calls from either extension.

Twining is available only if your system administrator has configured it for your system.

To twin your phone:

- | | |
|---------------------------------|--|
| Feature <input type="text"/> | 1. Press the Feature soft key. |
| Twin <input type="text"/> | 2. Press the Twin soft key. The screen displays the message Twining? |
| Yes <input type="text"/> | 3. Press the Yes softkey. The screen displays the last number to which calls were twinned. |
| Enable <input type="text"/> | 4. Specify the phone number of the device that you want to twin your deskphone with: — To twin calls with the previously used number, press the Enable soft key. The screen displays the confirmation message <code>Activation OK</code> to confirm that twining is enabled. |
| OR | OR |

Edit

Done

Enable

- To twin calls a different number, press the **Edit** soft key and enter the new number.
- Press the **Done** soft key to save the new number.
- Press the **Enable** soft key. The screen displays the confirmation message `Activation OK` to confirm that twinning is enabled.

To disable twinning:

Feature

Twin

Yes

Yes

1. Press the **Feature** soft key.
The screen displays the message `Feature`.
2. Press the **Twin** soft key.
The screen displays the message `Twinning?`
3. Press the **Yes** softkey.
The screen displays the prompt `Disable Twinning?`
4. Press the **Yes** softkey.
The screen displays the message `Deactivation OK`.

Configuring Privacy settings

You can restrict caller information coming to the IP Deskphone or caller information leaving the IP Deskphone. You can restrict the name, SIP address, or both from appearing on the screen.

Incoming call privacy

You can restrict the information for incoming calls to your IP Deskphone by configuring the Incoming Call Privacy setting.

To configure Incoming Call Privacy:

Prefs



1. Press the **Prefs** context-sensitive soft key, select **Misc Options**, and then **Incoming Privacy** from the menu.

Change



2. Choose one of the following:
 - Press the **Change** context-sensitive soft key to change the Incoming Privacy restriction to the highlighted restriction.

Back



- Press the **Back** context-sensitive soft key to return to the previous menu without implementing any changes.



3. Press the **Up/Down** navigation key to highlight one of the following:
 - None (no restriction)
 - Name (restricts only the name)
 - Address (restricts only the address)
 - All (restricts name and number)

Outgoing call privacy

You can restrict the information for outgoing calls from your IP Deskphone by configuring the Outgoing Call Privacy setting.

To configure Outgoing Call Privacy:

Prefs



1. Press the **Prefs** context-sensitive soft key, select **Misc Options**, and then **Outgoing Privacy** from the menu.

Change



2. Choose one of the following:
 - Press the **Change** context-sensitive soft key to change the Outgoing Privacy restriction to the highlighted restriction.
 - Press the **Back** context-sensitive soft key to return to the previous menu without implementing any changes.

Back



3. Press the **Up/Down** navigation key to highlight one of the following:
 - None (no restriction)
 - Name (restricts only the name)
 - Address (restricts only the address)
 - All (restricts name and number)



Audio Codecs

This feature allows you to specify a codec to which you can switch to during an active call. You can use the Preferences menu to modify the order of preference of the codecs between calls.

You can select an audio codec by name during a call, or while the handset is idle. The Audio Codecs feature also gives you control over the audio configuration that is used for inbound and outbound calls.

To change the codec while on the call, select **Audio, Change codec**, and then press **OK**.

The following context-sensitive soft keys are available on the Audio Codes page:

- **Ok**—to view the Audio Codec Selection screen.
- **Back**—to return to the previous screen.

Audio Codec Selection

The Audio Codec Selection allows you to select a codec to use during inbound and outbound calls.

The following context-sensitive soft keys are available for selecting the audio codes:

- **Select**: The IP Deskphone attempts to renegotiate the codec for the current call to use the selected codec.
- **Back**: Allows you to return to the Audio Codec screen.

Audio Codec Ordering

The Audio Codec Ordering allows you to modify the order of preference of codecs to use during inbound and outbound calls.

The following context-sensitive soft keys are available for the audio codec ordering page:

- **Save**—to save the current order as the new preferred codec order.
- **MoveUp**—to move the highlighted codec up in the list.
- **MoveDwn**—to move the highlighted codec down in the list.
- **Back**—to return to the Audio Codec screen.

The Audio Codec Ordering screen allows you to modify the order of preference of the codecs. You can reorder the preferences, and the changes to the ordering are saved.

Automatic remote firmware updates

Note: Your system administrator must enable **Remote check for update** for this feature to work.

Your IP Deskphone can be configured to perform automatic firmware updates. If this feature is configured, the IP Deskphone displays when a firmware update is scheduled to occur, and **Yes** and **No** context-sensitive soft keys are displayed. If the IP Deskphone is idle and no key is pressed, the firmware update begins in one minute.

If you press **Yes**, the firmware download begins.

If you are using your IP Deskphone (this includes on hold, on a conference call, or when your IP Deskphone is ringing) and you press **No**, the call is not disconnected and the firmware update does not occur. The IP Deskphone displays the firmware download prompt again in three minutes a total of three times.

If, after the third notification, you press **No** or no key is pressed, the firmware update does not occur. Your IP Deskphone attempts the firmware download process again in two hours.

Note: If you allow the update to proceed and the server is down, the IP Deskphone does not ask for updates again.

Screensaver/screen lock

You can lock the display of the IP Deskphone using a timed Screensaver/Lock.

When the screensaver is active, it clears the programmed keys of the plugged-in Expansion Module. If you have logged into the IP Deskphone, then you are not logged out, but the line key label clears and makes the IP Deskphone inactive.

The **ScrnSvr** context-sensitive soft key is located on the idle screen. This key is available only if the screensaver is enabled, and is accessed by pressing the **More...** context-sensitive soft key until **ScrnSvr** appears. Pressing the **ScrnSvr** context-sensitive soft key causes the current

screensaver timer to turn off, and activates the previously-selected screensaver.

Select the Display Screensaver menu item to display the screensaver settings screen.

The screensaver settings screen allows you to enable or disable your screensaver/lock. You can also configure various settings such as the delay before the screensaver starts, the background image to use, and the banner text to display when the screensaver/lock is active.

The following are the items on the displayed list:

- **Mode**—to enable or disable the screensaver and choose if the screensaver is to be password protected.
- **Delay**—to configure the time delay before the screensaver is invoked.
- **Image**—to select the background image to display when the screensaver is active.
- **Text**—to configure the text that appears on screen when the screensaver is active.

The following are the options available for the screensaver settings menu:

- **Select**—to select the currently highlighted setting.
- **Back**—to dismiss the screensaver setting.

Selecting the screensaver setting screen

The screensaver mode settings screen allows you to enable or disable the screensaver/lock.

Choose **Prefs**, **Display** and then select **Display Screensaver** to display the screensaver settings screen.

The screensaver mode setting lists the following items:

- **Disable**—to the disable the screensaver.
- **Enable (no password)**—to enable the screensaver with a password free mode.

- **Enable (with password)**—to enable the screensaver with a password mode.

The following are the options available for the screensaver settings menu:

- **Select**—to select the currently highlighted setting.
- **Back**—to dismiss the screensaver mode menu.

Note: Some options do not appear, depending on configuration.

Disabling the Screensaver displays a message confirming your selection.

Enabling the screensaver in **no password** mode displays a message confirming your selection.

Note: If the device configuration does not allow the use of a password free screensaver, this menu option is unavailable to you.

Enabling the screensaver in **password protected** mode prompts you to enter the password before logging in.

The screen lets you launch the user-defined password definition screen if it is enabled in the configuration.

The text on screen displays *Enter user password to activate screensaver* followed by a user input prompt.

The options, which are available for the Enable (with password) mode are as follows:

- **Ok**—Screensaver enabled message appears if the password is valid. Invalid password message appears if the password is invalid.
- **123/abc**—to toggle input mode between numeric or alphabet.
- **Set**—context-sensitive soft key appears only if the feature allows the setting of user-defined passwords. This key invokes a password definition screen that allows you to configure a password.
- **Back**—to dismiss the Enable (with password) mode menu.

If the option to use a user-defined password is allowed, the interface (screen) to configure the password, is accessed through the **Set** context-sensitive soft key on that screen. If a user-defined password is not

allowed, then the **Set** context-sensitive soft key is not visible, and you can use only the primary user login password to enable the password-protected screensaver.

After the screensaver is activated, if the IP Deskphone is idle for the defined delay/time interval, the screensaver takes control of the IP Deskphone.

The following option is available for the Enable (with password) mode:

- **Unlock**—if the screensaver is not password protected, this key press (or any other) cancels the screensaver. If the screensaver is in a password-protected mode, pressing the **Unlock** context-sensitive soft key invokes a password input screen. The password must be correctly entered to cancel the screensaver.

If you enable the screensaver with **no password** mode:

- Any user interaction, key presses, mouse movement, or incoming call cancels the screensaver (without requiring a user password). This includes pressing the **Unlock** context-sensitive soft key.
- The programmed keys of attached Expansion Module(s) are cleared until the screensaver is deactivated. If you have logged on to the IP Deskphone, you are not logged out, but the line key labels clear and are inactive until the screensaver is deactivated.

If you reboot the IP Deskphone when there is an active screensaver:

- If you have enabled autologin, then the screensaver remains active after the IP Deskphone reboots and completes the login.
- If you have not enabled autologin, then the screensaver setting remains enabled, but not active, after you log back into the IP Deskphone manually.

If you enable the screensaver with a password protected mode:

- User interaction, key presses, and mouse movements do not cancel the screensaver.
- An incoming call displays showing caller ID and allows you to answer the call. You cannot make outgoing calls, except an emergency call, until you unlock the IP Deskphone. An **Unlock** context-sensitive soft key appears on the screen. You can unlock the IP Deskphone after answering the call.

- Pressing the **Unlock** context-sensitive soft key prompts you to enter the password for the screensaver. The primary user line key is displayed (but not active) during the password prompt to give an indication about whose password is in use.
- Picking up the handset and dialing digits activates the line function display for emergency calls only. If you try to place an outgoing call, a message is displayed and the screensaver starts again.
- If you make an emergency call while the screensaver is active, the call is placed using the primary user.
- The Network menu is accessible to administrators (double press of the services key) even when the screensaver is active.
- If user-defined passwords are allowed, a mechanism to disable the screensaver (allowing the administrator to reset the user-defined password) is accessible through the network menu. This mechanism also invokes remotely from the IP Deskphone console through an SSH connection.
- All expansion modules are cleared of programmed keys until the screensaver is deactivated.
- If you reboot the IP Deskphone when there is an active screensaver:
 - If autologin is enabled, then the screensaver remains active after the IP Deskphone reboots and completes the login.
 - If autologin is not enabled, then the screensaver setting remains enabled but not active after you log back into the IP Deskphone manually.

Selecting an image to be viewed as a slideshow.

You can display all of the screensaver images that have been uploaded to your IP Deskphone in a slideshow format.

These files are loaded on the IP Deskphone using the USB flash drive.

Images for the 1140E IP Deskphone cannot exceed 128 KB. The images must be resized before they are loaded onto the IP Deskphone. The image size for the 1140E is 240 x 88.

Images can be displayed as a slideshow. Choose **Prefs, Display, Display Screensaver, Images** and then select **Slideshow**.

Background image

The IP Deskphone displays background images on the screen. From the preferences menu, you can browse the stored images on the file system and select an image for the user interface.

Selection of the menu item takes you to a new display list that contains all the available image files on the Flash File System.

Selecting an image screen

Select an image from a list of images currently stored on the Flash File System of the device.

1. To select background image, press the **Prefs** context-sensitive soft key, choose **Display**, and then **Background Image**.
2. The following are the options available for the background selection screen.
 - **Select**—to select the currently highlighted image.
 - **Back**—to dismiss the Image selection screen.

After you select the background image you want to use, the confirmation screen appears.

Note: If the selected image is not effective, you need to cancel the selection.

3. The following are the options available for the background confirmation screen.
 - **OK**—to configure the selected image as background image.
 - **Cancel**—to cancel the selection. Also, the selected image is disregarded and returns to Images list screen if the screen time-outs after 15 seconds.

USB flash memory device support

The IP Deskphone supports the browsing of files on a USB flash memory device. A simple file browser allows you to select an image file (or other type of file) and upload onto the IP Deskphone file system. The file

manager also allows you to browse and copy certain files from the phone file system onto a USB flash drive.

After you select the File Manager menu by choosing Services menu, you can navigate to the IP Deskphone file system and any USB drives attached. From there, you can either copy a file from the IP Deskphone onto their USB drive or from the USB drive to the IP Deskphone.

After you select a File manager, and there are no USB drives plugged into the IP Deskphone, the root screen of the IP Deskphone file system screen the screen that appears.

The following are the options available for the Root screen:

- **Select**—use to enter the selected folder.
- **Delete**—prompts you to delete contents of selected folder (folders are not deleted because they are on the IP Deskphone).
- **Exit**—If you are at the root folder of the flash disk, the screen is dismissed and you are sent back to previous menu. If you are already inside a folder, then the **Back** context-sensitive soft key acts the same as the **..** item and moves up one level in the directory structure.

After you select a File manager, and if the USB drives are plugged into the IP Deskphone, the screen that appears next is the **Select Device** screen. This screen lists the IP Deskphone, and USB drives that are available. After you select one of the items, the contents of that device (folders and files appears), and **..** allows you to navigate back to the select drive screen.

The following are the options available for the Select Device screen:

- **Select**—to enter the selected device.
- **Exit**—to dismiss the file manager and returns to the Services menu.

After you select the device you want to navigate, one of the following screens in [Figure 21 on page 232](#) appears:

Figure 21: File manager device browsing screen

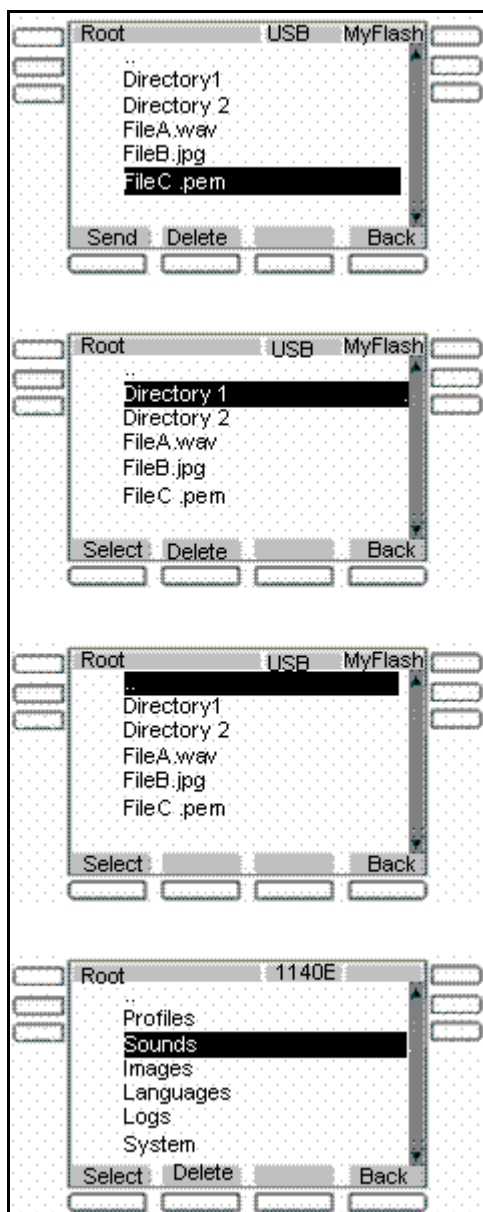

The file manager browsing screen provides the following options:

Note: The context-sensitive soft keys change based on the selected item on the screen.

- **Select**—to enter into the selected folder.
- **Back**—to return to the previous screen
- **Delete:**
 - If you select a file, it prompts for deletion and deletes files. If you do not respond to the deletion prompt in 15 seconds, deletion is cancelled.
 - If you select a folder on IP Deskphone, it prompts for deletion of all contents of the folder but not the folder.
 - If you select a folder on USB device, it prompts for deletion of folder and all its contents. If you do not respond to the deletion prompt in 15 seconds, deletion is cancelled.
- **Send**—appears only after you select a file.
 - If you select a file on a USB device and press **Send**, you can send or copy the selected file to the IP Deskphone. Based on the file extension, the destination folder gets selected automatically (for example: PNG files are sent directly to Images folder on the IP Deskphone).
 - If you select a file on the IP Deskphone and press **Send**, an error message appears if there is no USB drive that is currently plugged into the IP Deskphone. Sending files from the IP Deskphone to another location on the IP Deskphone is not allowed.
 - If you select a file on the IP Deskphone and press **Send**, you are directed to the USB folder you want to send the file to [Select Destination Screen] while a USB drive is plugged in on the IP Deskphone.
- **Back**—to dismiss the current screen and returns you to the device selection screen.

File Manager Select Destination prompt screen

The File Manager Select Destination prompt screen allows you to select the folder you wish to send or copy the previously selected file into.

The following are the options available for the Select Destination screen.

- **OK**—to enter in to the selected folder.
- **Back**—to return to the previous screen.

After you have confirmed to send a file from the IP Deskphone to the USB drive, the Select Destination screen appears.

Note: The context-sensitive soft keys change based on the selected item on the screen.

Select—to enter the selected folder.

Done—to configure the current location as the destination for the send and initiates copy operation.

Back—to return to the previous screen.

Notes on File Manager

General notes for File Manager are as follows:

- Selection of the **..** item (or **Back** context-sensitive soft key) moves you one level up which results in going off the device and onto the **select device** screen in some cases. In the case of the current selection being a sub folder, the selection of **..** or the **Back** context-sensitive soft key has the identical behavior of moving up one level.
- Selection of a file causes the selected file to copy on to the IP Deskphone flash file system, or to invoke a specific handler for the selected file (configured after this screen is invoked by other mechanisms). Specific example of this is a device configuration file which causes the IP Deskphone to update with selected file rather than to copy the file to a folder.
- Based on the extension of the selected file, validation routines runs to verify the file size, the free space available on the FFS, including restrictions that can be defined for safe usage (example limit of XX images or ring tones on the IP Deskphone [based on model]).
- Files having unknown extension must not be available for any action. The IP Deskphone attempts to perform actions of file types and extensions it recognizes.

Scenarios for the use of the USB screens are as follows:

Scenario 1 - If you want to copy an image file from the USB drive into the IP Deskphone:

- Log on to the device and plug the USB flash drive into the IP Deskphone USB port.
- Press the **Services** hard key and choose **File Manager**.
- Select **Flash Disk device**. The contents of the device are displayed.
- Select the file you wish to copy and then press **Send**.
- You are prompted to select the device you wish to send the selected file.
- Select the IP Deskphone as the destination device.
- The file is validated based on the file extension and the passing of the validation routines and a handler is called for the file. In this case, the image file copies the **images** directory of the flash file system on the IP Deskphone.
- A success message appears on the screen displaying that the file is copied to the IP Deskphone successfully.

After a file is selected, there can be multiple reasons why the handling cannot complete. This issue can be caused when the file size exceeds allowed limits, when there is not enough space on disk, when a file with the same name already exists, or when actions on the selected file type aren't allowed (configuration flag).

Error conditions display a message on the screen, and any action that takes some time to complete displays the *In progress...* message.

Scenario 2 - If you want to copy the ring tone from the IP Deskphone into the USB drive:

- Log into the device and plug the USB flash drive into the USB port of the IP Deskphone.
- Press the **Services** hard key and choose **File Manager**.
- Select the IP Deskphone from the select device screen.
- The contents of their IP Deskphone are displayed. Navigate to **Sounds** folder.

- Select the file you require and press the **Send** context-sensitive soft key.
- You are prompted to select the destination folder on the plugged in USB drive.
- Navigate to the folder **MyRings** and press the **Done** context-sensitive soft key to start the operation.
- The file is then validated (some files are not allowed to copy) and sent to the selected destination appears on the screen displaying that the file is copied on the IP Deskphone.

If file copying cannot complete due to insufficient space on the USB device, or due to the selected file type not being enabled in the File Manager (device configuration), then an error message is displayed on the screen.

An error message displays on the screen due to insufficient space on the USB device, or the selected file type not being enabled in the File Manager (device configuration).

Maintaining the IP Deskphone

The following chapter describes the following advanced features:

- “Viewing the IP Deskphone information” on page 237
- “Accessing the services menu” on page 239
- “Network menu” on page 247

Viewing the IP Deskphone information

You can view phone information for the IP Deskphone.

To view the Phone Information for the IP Deskphone:



Services

1. Press the **Services** hard key and select **Phone Information** from the menu.

You can view the following information:

- Load Ver
- Software
- E.M Software
- Presence
- FeatActv
- Srv Pkg Location

Note: You cannot make any changes to the setting from this menu.

Viewing additional phone information

When you view the Phone Information menu, you can use the following context-sensitive soft keys to display additional information:

- **Details**

- **E911**
- **USB**

The **Details** soft key lists the following information:

- Primary User
- Primary Domain
- MAC
- IP
- License server
 - Status

The contents of this screen include user and IP Deskphone identifiable information that needs to be protected (per US Federal/DoD requirements/guidelines).

Attention: The administrator can disable the **Details** context-sensitive soft key on the main Phone Information screen to hide information that is protected. If the **Details** context-sensitive soft key is disabled, you cannot view details on the Phone Information details screen.

To view information about the USB port press the **USB** context-sensitive soft key after you access the **Phone Information** screen. The screen displays the name of the USB device, if attached. You can use a standard USB flash drive to upload specific files or preferences into the IP Deskphone.

To view information about E911 press the **E911** context-sensitive soft key after you access the **Phone Information** screen.

Accessing the services menu

Some of the system features require your user password. You must consult with the system administrator or service provider before you can access some of the features.



Services

1. Press the **Services** hard key.

The IP Deskphone displays the following menu:

1. Search—use to perform local/global search.
2. Login.
3. Logout— use to logoff the IP Deskphone. For more information, see [“Logging off from the IP Deskphone” on page 76](#).
4. Check for Updates—use to check for the latest firmware update for the IP Deskphone. For more information, see [“Checking for updates” on page 239](#).
5. Reset Phone— use to perform a reset of the IP Deskphone. For more information, see [“Resetting the IP Deskphone” on page 240](#).
6. File Manager—For more information, see [“Erasing the user data” on page 242](#).
7. Logging System—use to enable/disable SIP logging.
8. Phone Information—use to view deskphone details. For more information, see [“Viewing the IP Deskphone information” on page 237](#).

Checking for updates

You can check for the latest firmware update for your IP Deskphone.

To check for the latest firmware update:



Services

1. Press the **Services** fixed key.

2. Select **Check For Updates**.

Select

3. Press the **Select** context-sensitive soft key.

Yes

4. Choose one of the following:

— Press the **Yes** context-sensitive soft key check for the latest firmware update for your IP Deskphone.

— Press the **No** context-sensitive soft key to return to the previous menu without checking for an update.

No

Note: While the IP Deskphone checks for an update, it activates Do Not Disturb (DND).

Resetting the IP Deskphone

You can use this feature to reset the phone without unplugging the power cable.

To reset the IP Deskphone:



Services

1. Press the **Services** fixed key, and then select **Reset Phone**.

Select



2. Press the **Select** context-sensitive soft key.

abc



3. Press the **abc/123** context-sensitive soft key to toggle between alphabetic or numeric input.



4. Use the dialpad to enter your password.

Ok



5. Choose one of the following:

- Press the **Ok** context-sensitive soft key.
- Press the **Back** context-sensitive soft key to return to the previous menu.

Back



Yes



The IP Deskphone prompts you with **Reset Phone?**.

6. Choose one of the following:

- Press the **Yes** context-sensitive soft key to proceed.
- Press the **No** context-sensitive soft key to return to the System menu.

No



Erasing the user data

The IP Deskphone stores user files that you eventually want to delete. These files include:

1. Profiles—user profile settings
2. Sounds—downloaded tones or audio alerts
3. Languages—downloaded language files
4. System file—IP Deskphone system configuration file (Deleting this file returns the IP Deskphone to the factory default configuration settings.)

You can delete some or all of these files. The deletion of files is often necessary when the IP Deskphone is redeployed to a different user.

To delete user data files:



1. Press the **Services** fixed key.

2. Select **File Manager**.

Note: You must enter your login password to access the File Manager menu.

abc



3. Press the **abc/123** context-sensitive soft key to toggle between alphabetic or numeric input.



4. Use the dialpad to enter your password.

Ok



Back



5. Choose one of the following:
 - Press the **Ok** context-sensitive soft key.
 - Press the **Back** context-sensitive soft key to return to the previous menu.

6. Press the **Up/Down** navigation key to highlight one of the following:
 - Profiles
 - Sounds
 - Languages
 - System file
 - All files

Select



Delete



Exit



Back



7. Choose one of the following:

- To enter the selected folder, press the **Select** context-sensitive soft key.
- To delete contents of the selected folder, press the **Delete** context-sensitive soft key.

Note: Folders cannot be deleted because they are on the IP Deskphone.

- If you are at the root folder of the flash disk, press the **Exit** context-sensitive soft key to return to the previous menu.
- If you are already inside the folder, press the **Back** context-sensitive soft key to return to the previous menu.

To delete a user profile:



Delete



Back



1. Press the **Up/Down** navigation key to highlight the user profile you want to delete.

2. Choose one of the following:

- Press the **Delete** context-sensitive soft key to delete the highlighted user profile from the list.
- Press the **Back** context-sensitive soft key to return to the previous menu.

3. Log off or restart the IP Deskphone to complete the process.

To delete a sound file:



Delete



Back



1. Press the **Up/Down** navigation key to highlight the sound file you want to delete.
2. Choose one of the following:
 - Press the **Delete** context-sensitive soft key to delete the highlighted sound file from the list.
 - Press the **Back** context-sensitive soft key to return to the previous menu.

To delete a language file:



1. Press the **Up/Down** navigation key to highlight the language file you want to delete.

Delete



Back



2. Choose one of the following:
 - Press the **Delete** context-sensitive soft key to delete the highlighted language file from the list.
 - Press the **Back** context-sensitive soft key to return to the previous menu.

To delete a log file:



Delete



Back



1. Press the **Up/Down** navigation key to highlight the log file you want to delete.
2. Choose one of the following:
 - Press the **Delete** context-sensitive soft key to delete the highlighted language file from the list.
 - Press the **Back** context-sensitive soft key to return to the previous menu.

To delete the system file without deleting the user profile:



1. Choose one of the following:
 - Press the **Next** context-sensitive soft key to delete the system file.
 - Press the **Back** context-sensitive soft key to return to the previous menu.

2. Log out or restart the IP Deskphone to complete the process.

To delete all files:



1. Choose one of the following:
 - Press the **Next** context-sensitive soft key to delete the system file and user profiles.
 - Press the **Back** context-sensitive soft key to return to the previous menu.

2. Log out or restart the IP Deskphone to complete the process.

Network menu

Primarily, the system administrator is the only person authorized to access the network menu and to use an administration password to access the items.

The following Network menu items are available:

- Server Settings—to select and edit domains

- Device Settings—to configure the network settings
- Diagnostics—to run a trace route or send a ping to diagnose the network connection
 - IP Set and DHCP information
 - Network Diagnostics tools
 - Ethernet Statistics
 - IP Network Statistics
 - USB Devices
 - Advanced Diag Tools
 - Test Key
- Lock Menu—to access to the Network Menu

To access the Network menu:



Services

Prefs



1. Choose one of the following:

- Press the **Services** fixed key twice quickly.
- Press the **Prefs** context-sensitive soft key, and then select **Network** from the menu.

Note: You need to enter an administration password to access the Network menu items.

Visual indicators

The IP Deskphone uses visual indicators or cues to indicate incoming calls and messages. The display icons on the IP Deskphone also indicate the current call state.

Display screen icons

Table 17 on page 249 lists the display icons of the IP Deskphone.

Table 17: Display screen icons (Part 1 of 2)











| Component | Icon |
|--|---|
| Call State | |
| On hook |  |
| Incoming/Outgoing call (phone ringing) |  |
| On the phone |  |
| On hold |  |
| Missed call |  |
| Feature button icons | |

Table 17: Display screen icons (Part 2 of 2)

| Component | Icon |
|--------------------------------|---|
| Speed Dial list |  |
| Inbox | |
| Incoming Call Answered |  |
| Incoming Call Missed, New |  |
| Incoming Call Missed, Reviewed |  |
| Unknown |  |

Visual Alerter/Message Waiting Indicators

The red LED light at the top right of the IP Deskphone lights to indicate incoming calls or when a caller leaves you voice mail.

[Table 18 on page 250](#) lists the visual indicator and the LED status.

Table 18: Visual Alerter/Message Waiting Indicator



| LED | Visual indicator | LED status |
|---------|-------------------------------|---|
| Red LED | Voice mail left by caller | Steady red light until message is reviewed. |
| | Incoming call (phone ringing) | Fast blinking red light. |

Monitoring other extensions

Your system administrator can enable you to monitor the status of other lines. When this feature is enabled, you can use the visual indicators on your IP deskphone to monitor whether other extensions are idle or busy. You can also answer calls to those extensions.

Table 19 on page 251 lists the status visual indicators that the IP deskphone uses to show the status of the line that you are monitoring.

Table 19: Visual indicators for monitored lines

| Icon | Line status |
|---|-------------|
|  | Idle |
| Flashing  | Ringing |
| Solid  | Busy |









Quick reference

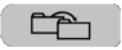





This section provides a quick reference guide for the Avaya 1140E IP Deskphone. See the following sections for more information:









- “Fixed keys” on page 253
- “Commonly used functions” on page 255
- “Context-sensitive soft keys” on page 257
- “Display screen icons” on page 260

Fixed keys

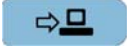
The Avaya 1140E IP Deskphone is available with either icon fixed keys or English text fixed keys. Both types are presented below.

| Short-cut and navigation function keys | |
|---|--|
|   | Copy information from the Address Book, Inbox, Outbox, and IM log and to Feature keys and Address Book entries. |
|   | Access Search, Login, Logout, Check For Updates, Reset Phone, File Manager, Logging System, and Phone Information. Press twice quickly to access the Network menu. |
|   | Quit or exit from a menu. |
|   | Access your inbox to view all calls or missed calls and to return a call. |

| | |
|---|--|
|  <i>Shift/Outbox</i> | <p>Access your outbox to view all calls made and to place a call to a previously called contact.</p> |
|  <i>Directory</i> | <p>Access your address book to view, add or edit entries including your designated friends You can also send Instant Messages (IMs) or initiate a call.</p> |
|  | <p>Use the Enter key to select highlighted menu items and to set preferences. The Enter key duplicates the function of the phone and select context-sensitive soft keys.</p> |
| <p>Telephone feature keys</p> | |
|  <i>Volume +</i> | <p>Use to increase the volume of the handset, headphones, phone speaker (handsfree) and alerting volume (phone ringing).</p> |
|  <i>Volume -</i> | <p>Use to decrease the volume of the handset, headphones, phone speaker (handsfree) and alerting volume (phone ringing).</p> |
|  <i>Mute</i> | <p>Use mute to listen to the call without transmitting. The red LED on the Mute key lights when the Mute feature is enabled.</p> |
|  <i>Handsfree</i> | <p>Activates the built in speaker and microphone. The red LED on the Handsfree key lights when the Handsfree feature is enabled.</p> |

| | |
|---|--|
|   | <p>Use to release a call (hang up) and to exit a menu when not on an active call.</p> |
|   | <p>Access Instant Message log to view and send IMs</p> |
|   | <p>Activates your IP Deskphone headset when connected. The red LED of the Headset key lights when you use a headset.</p> |
|   | <p>Use to place a call on hold or to retrieve a call on hold.</p> |

Note: The **abc/123** context-sensitive soft key toggles between alphabetic and numeric input. When the context-sensitive soft key label is **abc**, you can enter alphabetic text and when the context-sensitive soft key label is **123**, you can enter numbers.

Commonly used functions

Procedures for the most commonly used functions are provided below.

Login

1. Enter your User ID and press the **Login** key.
2. Enter your password and press the **Next** key.
3. To permanently login, press the **Next** key.
To login for a period of time, press the **Timed** key, enter the duration of your login, and press the **Next** key.

Logout

1. Press the **Services** hard key and then select **Logout**.
2. Press the **abc/123** context-sensitive soft key to toggle between alphabet and numeric input.
3. Press **Logout** context-sensitive key.

Making a call

- Lift the **Handset** or press the **Headset** key, **Handsfree** key or the **Line** key and enter the SIP address or phone number and press send. Or, press the **Redial** key to call the previously entered SIP address or phone number.
- Press the **Services** hard key, select **Search**, select an entry in the Address Book, and then press the **Call** key. Lift the **Handset** or press the **Headset** key, **Handsfree** key or the **Line** feature key and dial from the Address Book or Inbox/Outbox as follows:
 - 1. Press the **Address Book** or **Inbox** or **Outbox** key.
 - 2. Navigate to the required entry.
 - 3. Press the **Select** key to connect.

Answering a call

Perform one of the following to answer a call:

- Press the **Handsfree** key
- Press the **Headset** key
- Press the **Line** key
- Press the **Answer** key
- Pick up the **Handset**.

If you choose not to answer the call, you can press one of the following keys:

- **Redrct**—Redirects the call to another party or number.
- **Decline**—Rejects the call and provides the caller with fast busy and no option to go to voice mail. You can provide a reason for declining the call.

Ignore—Stops call ringing

Making an emergency call

To make an emergency call, logging on is not required. Choose one of the following options:

- Lift the **Handset** and dial the emergency number.
- Press the **Handsfree** key and dial the emergency number.
- Press the **Headset** key and dial the emergency number.

Context-sensitive soft keys

The following context-sensitive key menus are provided below:

- “Idle phone display” on page 257
- “Active call display” on page 259

Idle phone display

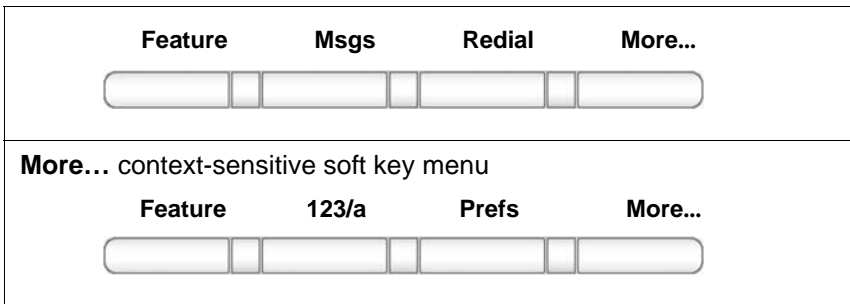

When you press the **More...** context-sensitive soft key for the third time, you return to the first menu list.

A description of the context-sensitive soft keys available with the phone is idle is provided below.

| | |
|--------------------------------|--|
| Redial or NewCall | |
| Redial the last dialed number. | |
| | <ul style="list-style-type: none"> • If there is no stored redial number, NewCall appears and has the same effect as pressing the primary user line key (dial prompt). |
| abc or 123 | |

Toggle between alpha and numeric input modes.

- To type letters, **abc** must be displayed.
- To type numbers, press **abc** to display **123** on the menu list.

Msgs

Display the Messages menu.

1. Voice Mail—Use to access your Voice Mail. The IP Deskphone connects to the server to retrieve your Voice Mail.

ScrnSvr

Activate the screensaver (only if the screensaver feature is enabled).

Prefs

Display the Preferences menu.



- 1. Display**—Adjust screen display settings.
- 2. Audio**—Adjust tones and volume settings, configure a USB headset, and access the Bluetooth wireless technology setup.
- 3. Feature Options**—Program feature keys, call decline reasons, call ignore actions, and call subjects, call fwd notification.
- 4. Language**—Change language.
- 5. Misc Options**—Set alpha dialing, search method, privacy settings, # Ends dialing, location, and time.
- 6. Network**—Access Server Settings, Device Settings, Diagnostics and Lock.
- 7. USB Locks**—Enable or disable USB devices.
- 8. User Settings**—Modify call settings, IM settings, voice mail setting, and remembering settings.

More

Select a new menu list.

- When you press **More...**, the following context-sensitive soft keys appear:
 - **[abc] or [123]**
 - **[Prefs]**

Active call display

| |
|--|
| <p>Feature Conf Trans More...</p>  |
| <p>More... context-sensitive soft key menu</p> <p style="text-align: center;"> Feature Audio New Call More... </p>  |
| <p>More... context-sensitive soft key menu</p> <p style="text-align: center;"> Feature Prefs More... </p>  |

When you press the **More...** context-sensitive soft key for the third time, you return to the first menu list.

A description of the context-sensitive soft keys available with the phone is idle is provided below.

| | |
|-----------------|--|
| Conf | |
| | <p>Obtain a dial tone to place another call during an active call.</p> <ul style="list-style-type: none"> • Use to make a conference call. |
| Transfer | |
| | <ul style="list-style-type: none"> • Transfer the current call to another location or contact. |
| Audio | |
| | <ol style="list-style-type: none"> 1. Change audio setting—Use to change the audio settings based on the available bandwidth. 2. Monitor audio quality—Diagnostic tool to monitor the audio quality. |
| NewCall | |

Obtain a dial tone to place another call during an active call.

- Use to make a conference call.
- Behaves like the **Conf** Context-sensitive soft key.

Prefs

See “Idle phone display” on page 257.

More...



Select a new menu list.







- When you press **More...**, a different selection of Context-sensitive soft keys appears.
 - Press once to switch to: **[NewCall]** .
 - Press twice to switch to: **[Prefs]** [] [] .
 - Press three time to switch back to the main menu list: **[Conf]** **[Trnsfer]** **[Audio]**.

Display screen icons

The table below provides a list of the following display screen icons:

- **Call state**—Icons to indicate the Call state of your phone.
- **Instant Messaging**—Icons displayed when you view your instant message log. The icon appears beside each IM to indicate the status.
- **Inbox**—Icons to indicate the status of each incoming calls in your Inbox.
- **Presence**—Icons to indicate the presence state of those address book entries you designate as Friend.

| Call state | Icon |
|--------------|---|
| On hook |  |
| On the phone |  |
| On hold |  |

| | |
|--|---|
| Call Forward (enabled) Forward>ext # is displayed |  |
| Do Not Disturb (enabled) |  |
| Outgoing call, Incoming call (ringing) |  |
| Missed call |  |
| Inbox | Icon |
| Incoming Call Answered |  |
| Incoming Call, Missed, New |  |
| Incoming Call, Missed, Reviewed |  |

Limitations

Table 20 on page 263 lists the limitations for Avaya 1140E IP Deskphones when used with IP Office 8.0.

Table 20: Limitations

| Item | Function |
|----------------------|--|
| Call Decline Reasons | Call Decline Reasons are not supported. A menu item for Call Decline Reasons displays on the IP deskphone when you select Prefs > Feature Options , but will not function. |
| # Ends Dialing | A menu item for # Ends Dialing displays on the IP deskphone when you select Prefs > Misc Options , but this feature is not supported. The option is disabled by default; do not change this setting. |
| Call Subject | The Call Subject feature is not supported. A menu item for Call Subject displays on the IP deskphone when you select Prefs > Feature Options , but information that you enter here will not be included in the call. |

Third party terms

Third Party Terms for Avaya 11xx 12xx sw release 3.x thru 4.x

Certain portions of the product ("Open Source Components") are licensed under open source license agreements that require Avaya to make the source code for such Open Source Components available in source code format to its licensees, or that require Avaya to disclose the license terms for such Open Source Components. For a period of three years from your date of purchase of a product containing any of the software listed below from Avaya Inc., any Avaya affiliate or an authorized Avaya reseller, we will provide upon request a complete machine readable copy of the source code for such Open Source Component on a medium customarily used for software interchange for a charge no more than our cost of physically performing source distribution. To get access to the source code, you may contact Avaya at (408) 577-7666.

The Open Source Components are provided "AS IS". ANY EXPRESS OR IMPLIED WARRANTIES, INCLUDING, BUT NOT LIMITED TO, THE IMPLIED WARRANTIES OF MERCHANTABILITY AND FITNESS FOR A PARTICULAR PURPOSE ARE DISCLAIMED. IN NO EVENT SHALL THE COPYRIGHT HOLDERS OR THE CONTRIBUTORS OF THE OPEN SOURCE COMPONENTS BE LIABLE FOR ANY DIRECT, INDIRECT, INCIDENTAL, SPECIAL, EXEMPLARY, OR CONSEQUENTIAL DAMAGES (INCLUDING, BUT NOT LIMITED TO, PROCUREMENT OF SUBSTITUTE GOODS OR SERVICES; LOSS OF USE, DATA, OR PROFITS; OR BUSINESS INTERRUPTION) HOWEVER CAUSED AND ON ANY THEORY OF LIABILITY, WHETHER IN CONTRACT, STRICT LIABILITY, OR TORT (INCLUDING NEGLIGENCE OR OTHERWISE) ARISING IN ANY WAY OUT OF THE USE OF THE PRODUCT, EVEN IF ADVISED OF THE POSSIBILITY OF SUCH DAMAGE.

The following component is licensed under Public Domain:

DateTime

*

PUBLIC DOMAIN NOTICE

* National Center for Biotechnology Information

*

* This software/database is a "United States Government Work" under the terms of the United States Copyright Act. It was written as part of the author's official duties as a United States Government employee and thus cannot be copyrighted. This software/database is freely available to the public for use. The National Library of Medicine and the U.S. Government have not placed any restriction on its use or reproduction.

*

* Although all reasonable efforts have been taken to ensure the accuracy and reliability of the software and data, the NLM and the U.S. Government do not and cannot warrant the performance or results that may be obtained by using this software or data. The NLM and the U.S. Government disclaim all warranties, express or implied, including warranties of performance, merchantability or fitness for any particular purpose.

*

* Please cite the author in any work or product based on this material.

*

* =====

*

* Authors: Anton Butanayev, Denis Vakatov, Vladimir Ivanov

END OF TERMS AND CONDITIONS

GNU

The following component is licensed under the GNU General Public V2 license:

libstdc++ Copyright (C) 1989, 1997, 1998, 1999 Free Software Foundation, Inc.

GNU General Public V2 License

GNU GENERAL PUBLIC LICENSE Version 2, June 1991 Copyright (C) 1989, 1991 Free Software Foundation, Inc. 59 Temple Place - Suite 330, Boston, MA 02111-1307, USA Everyone is permitted to copy and distribute verbatim copies of this license document, but changing it is not

allowed. Preamble The licenses for most software are designed to take away your freedom to share and change it. By contrast, the GNU General Public License is intended to guarantee your freedom to share and change free software--to make sure the software is free for all its users. This General Public License applies to most of the Free Software Foundation's software and to any other program whose authors commit to using it. (Some other Free Software Foundation software is covered by the GNU Library General Public License instead.) You can apply it to your programs, too. When we speak of free software, we are referring to freedom, not price. Our General Public Licenses are designed to make sure that you have the freedom to distribute copies of free software (and charge for this service if you wish), that you receive source code or can get it if you want it, that you can change the software or use pieces of it in new free programs; and that you know you can do these things. To protect your rights, we need to make restrictions that forbid anyone to deny you these rights or to ask you to surrender the rights. These restrictions translate to certain responsibilities for you if you distribute copies of the software, or if you modify it. For example, if you distribute copies of such a program, whether gratis or for a fee, you must give the recipients all the rights that you have. You must make sure that they, too, receive or can get the source code. And you must show them these terms so they know their rights. We protect your rights with two steps: (1) copyright the software, and (2) offer you this license which gives you legal permission to copy, distribute and/or modify the software. Also, for each author's protection and ours, we want to make certain that everyone understands that there is no warranty for this free software. If the software is modified by someone else and passed on, we want its recipients to know that what they have is not the original, so that any problems introduced by others will not reflect on the original authors' reputations. Finally, any free program is threatened constantly by software patents. We wish to avoid the danger that redistributors of a free program will individually obtain patent licenses, in effect making the program proprietary. To prevent this, we have made it clear that any patent must be licensed for everyone's free use or not licensed at all. The precise terms and conditions for copying, distribution and modification follow.

TERMS AND CONDITIONS FOR COPYING, DISTRIBUTION AND MODIFICATION

0. This License applies to any program or other work which contains a notice placed by the copyright holder saying it may be distributed under the terms of this General Public License. The "Program", below, refers to any such program or work, and a "work based on the Program" means either the Program or any derivative work under copyright law: that is to say, a work containing the Program or a

portion of it, either verbatim or with modifications and/or translated into another language. (Hereinafter, translation is included without limitation in the term "modification".) Each licensee is addressed as "you". Activities other than copying, distribution and modification are not covered by this License; they are outside its scope. The act of running the Program is not restricted, and the output from the Program is covered only if its contents constitute a work based on the Program (independent of having been made by running the Program). Whether that is true depends on what the Program does.

1. You may copy and distribute verbatim copies of the Program's source code as you receive it, in any medium, provided that you conspicuously and appropriately publish on each copy an appropriate copyright notice and disclaimer of warranty; keep intact all the notices that refer to this License and to the absence of any warranty; and give any other recipients of the Program a copy of this License along with the Program. You may charge a fee for the physical act of transferring a copy, and you may at your option offer warranty protection in exchange for a fee.
2. You may modify your copy or copies of the Program or any portion of it, thus forming a work based on the Program, and copy and distribute such modifications or work under the terms of Section 1 above, provided that you also meet all of these conditions:
 - * a) You must cause the modified files to carry prominent notices stating that you changed the files and the date of any change.
 - * b) You must cause any work that you distribute or publish, that in whole or in part contains or is derived from the Program or any part thereof, to be licensed as a whole at no charge to all third parties under the terms of this License.
 - * c) If the modified program normally reads commands interactively when run, you must cause it, when started running for such interactive use in the most ordinary way, to print or display an announcement including an appropriate copyright notice and a notice that there is no warranty (or else, saying that you provide a warranty) and that users may redistribute the program under these conditions, and telling the user how to view a copy of this License. (Exception: if the Program itself is interactive but does not normally print such an announcement, your work based on the Program is not required to print an announcement.)These requirements apply to the modified work as a whole. If identifiable sections of that work are not derived from the Program, and can be reasonably considered independent and separate works in themselves, then this License, and its terms, do not apply to those sections when you distribute them as separate works. But when you distribute the same sections as part of a whole which is a work based on the Program, the distribution of the whole must be on the terms of this License, whose permissions for other licensees extend to the entire whole, and thus to each and every part regardless of who wrote it.

Thus, it is not the intent of this section to claim rights or contest your rights to work written entirely by you; rather, the intent is to exercise the right to control the distribution of derivative or collective works based on the Program. In addition, mere aggregation of another work not based on the Program with the Program (or with a work based on the Program) on a volume of a storage or distribution medium does not bring the other work under the scope of this License. 3. You may copy and distribute the Program (or a work based on it, under Section 2) in object code or executable form under the terms of Sections 1 and 2 above provided that you also do one of the following: * a) Accompany it with the complete corresponding machine-readable source code, which must be distributed under the terms of Sections 1 and 2 above on a medium customarily used for software interchange; or, * b) Accompany it with a written offer, valid for at least three years, to give any third party, for a charge no more than your cost of physically performing source distribution, a complete machine-readable copy of the corresponding source code, to be distributed under the terms of Sections 1 and 2 above on a medium customarily used for software interchange; or, * c) Accompany it with the information you received as to the offer to distribute corresponding source code. (This alternative is allowed only for noncommercial distribution and only if you received the program in object code or executable form with such an offer, in accord with Subsection b above.) The source code for a work means the preferred form of the work for making modifications to it. For an executable work, complete source code means all the source code for all modules it contains, plus any associated interface definition files, plus the scripts used to control compilation and installation of the executable. However, as a special exception, the source code distributed need not include anything that is normally distributed (in either source or binary form) with the major components (compiler, kernel, and so on) of the operating system on which the executable runs, unless that component itself accompanies the executable. If distribution of executable or object code is made by offering access to copy from a designated place, then offering equivalent access to copy the source code from the same place counts as distribution of the source code, even though third parties are not compelled to copy the source along with the object code. 4. You may not copy, modify, sublicense, or distribute the Program except as expressly provided under this License. Any attempt otherwise to copy, modify, sublicense or distribute the Program is void, and will automatically terminate your rights under this License. However, parties who have received copies, or rights, from you under this License will not have their licenses terminated so long as such parties remain in full compliance. 5. You are not required to accept this License, since you

have not signed it. However, nothing else grants you permission to modify or distribute the Program or its derivative works. These actions are prohibited by law if you do not accept this License. Therefore, by modifying or distributing the Program (or any work based on the Program), you indicate your acceptance of this License to do so, and all its terms and conditions for copying, distributing or modifying the Program or works based on it. 6. Each time you redistribute the Program (or any work based on the Program), the recipient automatically receives a license from the original licensor to copy, distribute or modify the Program subject to these terms and conditions. You may not impose any further restrictions on the recipients' exercise of the rights granted herein. You are not responsible for enforcing compliance by third parties to this License. 7. If, as a consequence of a court judgment or allegation of patent infringement or for any other reason (not limited to patent issues), conditions are imposed on you (whether by court order, agreement or otherwise) that contradict the conditions of this License, they do not excuse you from the conditions of this License. If you cannot distribute so as to satisfy simultaneously your obligations under this License and any other pertinent obligations, then as a consequence you may not distribute the Program at all. For example, if a patent license would not permit royalty-free redistribution of the Program by all those who receive copies directly or indirectly through you, then the only way you could satisfy both it and this License would be to refrain entirely from distribution of the Program. If any portion of this section is held invalid or unenforceable under any particular circumstance, the balance of the section is intended to apply and the section as a whole is intended to apply in other circumstances. It is not the purpose of this section to induce you to infringe any patents or other property right claims or to contest validity of any such claims; this section has the sole purpose of protecting the integrity of the free software distribution system, which is implemented by public license practices. Many people have made generous contributions to the wide range of software distributed through that system in reliance on consistent application of that system; it is up to the author/donor to decide if he or she is willing to distribute software through any other system and a licensee cannot impose that choice. This section is intended to make thoroughly clear what is believed to be a consequence of the rest of this License. 8. If the distribution and/or use of the Program is restricted in certain countries either by patents or by copyrighted interfaces, the original copyright holder who places the Program under this License may add an explicit geographical distribution limitation excluding those countries, so that distribution is permitted only in or among countries not thus excluded. In such case, this License

incorporates the limitation as if written in the body of this License. 9. The Free Software Foundation may publish revised and/or new versions of the General Public License from time to time. Such new versions will be similar in spirit to the present version, but may differ in detail to address new problems or concerns. Each version is given a distinguishing version number. If the Program specifies a version number of this License which applies to it and \"any later version\", you have the option of following the terms and conditions either of that version or of any later version published by the Free Software Foundation. If the Program does not specify a version number of this License, you may choose any version ever published by the Free Software Foundation. 10. If you wish to incorporate parts of the Program into other free programs whose distribution conditions are different, write to the author to ask for permission. For software which is copyrighted by the Free Software Foundation, write to the Free Software Foundation; we sometimes make exceptions for this. Our decision will be guided by the two goals of preserving the free status of all derivatives of our free software and of promoting the sharing and reuse of software generally. NO WARRANTY

11. BECAUSE THE PROGRAM IS LICENSED FREE OF CHARGE, THERE IS NO WARRANTY FOR THE PROGRAM, TO THE EXTENT PERMITTED BY APPLICABLE LAW. EXCEPT WHEN OTHERWISE STATED IN WRITING THE COPYRIGHT HOLDERS AND/OR OTHER PARTIES PROVIDE THE PROGRAM \"AS IS\" WITHOUT WARRANTY OF ANY KIND, EITHER EXPRESSED OR IMPLIED, INCLUDING, BUT NOT LIMITED TO, THE IMPLIED WARRANTIES OF MERCHANTABILITY AND FITNESS FOR A PARTICULAR PURPOSE. THE ENTIRE RISK AS TO THE QUALITY AND PERFORMANCE OF THE PROGRAM IS WITH YOU. SHOULD THE PROGRAM PROVE DEFECTIVE, YOU ASSUME THE COST OF ALL NECESSARY SERVICING, REPAIR OR CORRECTION. 12. IN NO EVENT UNLESS REQUIRED BY APPLICABLE LAW OR AGREED TO IN WRITING WILL ANY COPYRIGHT HOLDER, OR ANY OTHER PARTY WHO MAY MODIFY AND/OR REDISTRIBUTE THE PROGRAM AS PERMITTED ABOVE, BE LIABLE TO YOU FOR DAMAGES, INCLUDING ANY GENERAL, SPECIAL, INCIDENTAL OR CONSEQUENTIAL DAMAGES ARISING OUT OF THE USE OR INABILITY TO USE THE PROGRAM (INCLUDING BUT NOT LIMITED TO LOSS OF DATA OR DATA BEING RENDERED INACCURATE OR LOSSES SUSTAINED BY YOU OR THIRD PARTIES OR A FAILURE OF THE PROGRAM TO OPERATE WITH ANY OTHER PROGRAMS), EVEN IF SUCH HOLDER OR OTHER PARTY HAS BEEN ADVISED OF THE POSSIBILITY OF SUCH DAMAGES. END OF TERMS AND CONDITIONS

How to Apply These

Terms to Your New Programs If you develop a new program, and you want it to be of the greatest possible use to the public, the best way to achieve this is to make it free software which everyone can redistribute and change under these terms. To do so, attach the following notices to the program. It is safest to attach them to the start of each source file to most effectively convey the exclusion of warranty; and each file should have at least the "copyright" line and a pointer to where the full notice is found. one line to give the program's name and an idea of what it does. Copyright (C) yyyy name of author This program is free software; you can redistribute it and/or modify it under the terms of the GNU General Public License as published by the Free Software Foundation; either version 2 of the License, or (at your option) any later version. This program is distributed in the hope that it will be useful, but WITHOUT ANY WARRANTY; without even the implied warranty of MERCHANTABILITY or FITNESS FOR A PARTICULAR PURPOSE. See the GNU General Public License for more details. You should have received a copy of the GNU General Public License along with this program; if not, write to the Free Software Foundation, Inc., 59 Temple Place - Suite 330, Boston, MA 02111-1307, USA. Also add information on how to contact you by electronic and paper mail. If the program is interactive, make it output a short notice like this when it starts in an interactive mode: Gnomovision version 69, Copyright (C) year name of author Gnomovision comes with ABSOLUTELY NO WARRANTY; for details type `show w`. This is free software, and you are welcome to redistribute it under certain conditions; type `show c` for details. The hypothetical commands `show w` and `show c` should show the appropriate parts of the General Public License. Of course, the commands you use may be called something other than `show w` and `show c`; they could even be mouse-clicks or menu items--whatever suits your program. You should also get your employer (if you work as a programmer) or your school, if any, to sign a "copyright disclaimer" for the program, if necessary. Here is a sample; alter the names: Yoyodyne, Inc., hereby disclaims all copyright interest in the program `Gnomovision` (which makes passes at compilers) written by James Hacker. signature of Ty Coon, 1 April 1989 Ty Coon, President of Vice This General Public License does not permit incorporating your program into proprietary programs. If your program is a subroutine library, you may consider it more useful to permit linking proprietary applications with the library. If this is what you want to do, use the GNU Lesser General Public License instead of this License.

END OF TERMS AND CONDITIONS

Zlib

The following component is licensed under zlib license:

Zlib 1.2.1

Zlib License

```
/* zlib.h -- interface of the 'zlib' general purpose compression library
version 1.2.4, March 14th, 2010
```

Copyright (C) 1995-2010 Jean-loup Gailly and Mark

This software is provided 'as-is', without any express or implied warranty. In no event will the authors be held liable for any damages arising from the use of this software. Permission is granted to anyone to use this software for any purpose, including commercial applications, and to alter it and redistribute it freely, subject to the following restrictions:

1. The origin of this software must not be misrepresented; you must not claim that you wrote the original software. If you use this software in a product, an acknowledgment in the product documentation would be appreciated but is not required.
2. Altered source versions must be plainly marked as such, and must not be misrepresented as being the original software.
3. This notice may not be removed or altered from any source distribution.

Jean-loup Gailly
Mark Adler

END OF TERMS AND CONDITIONS

Libpng

The following component is licensed under libpng license:

Libpng 1.2.37 - June 4, 2009

Libpng License

This copy of the libpng notices is provided for your convenience. In case of any discrepancy between this copy and the notices in the file png.h that is included in the libpng distribution, the latter shall prevail.

COPYRIGHT NOTICE, DISCLAIMER, and LICENSE:

If you modify libpng you may insert additional notices immediately following this sentence.

libpng versions 1.2.6, August 15, 2004, through 1.2.34, December 18, 2008, are Copyright (c) 2004, 2006-2008 Glenn Randers-Pehrson, and are distributed according to the same disclaimer and license as libpng-1.2.5 with the following individual added to the list of Contributing Authors

Cosmin Truta

libpng versions 1.0.7, July 1, 2000, through 1.2.5 - October 3, 2002, are Copyright (c) 2000-2002 Glenn Randers-Pehrson, and are distributed according to the same disclaimer and license as libpng-1.0.6 with the following individuals added to the list of Contributing Authors

Simon-Pierre Cadieux
Eric S. Raymond
Gilles Vollant

and with the following additions to the disclaimer:

There is no warranty against interference with your enjoyment of the library or against infringement. There is no warranty that our efforts or the library will fulfill any of your particular purposes or needs. This library is provided with all faults, and the entire risk of satisfactory quality, performance, accuracy, and effort is with the user.

libpng versions 0.97, January 1998, through 1.0.6, March 20, 2000, are Copyright (c) 1998, 1999 Glenn Randers-Pehrson, and are distributed according to the same disclaimer and license as libpng-0.96, with the following individuals added to the list of Contributing Authors:

Tom Lane
Glenn Randers-Pehrson
Willem van Schaik

libpng versions 0.89, June 1996, through 0.96, May 1997, are Copyright (c) 1996, 1997 Andreas Dilger
Distributed according to the same disclaimer and license as libpng-0.88, with the following individuals added to the list of Contributing Authors:

John Bowler
Kevin Bracey
Sam Bushell
Magnus Holmgren

Greg Roelofs
Tom Tanner

libpng versions 0.5, May 1995, through 0.88, January 1996, are Copyright (c) 1995, 1996 Guy Eric Schalnat, Group 42, Inc.

For the purposes of this copyright and license, "Contributing Authors" is defined as the following set of individuals:

Andreas Dilger
Dave Martindale
Guy Eric Schalnat
Paul Schmidt
Tim Wegner

The PNG Reference Library is supplied "AS IS". The Contributing Authors and Group 42, Inc. disclaim all warranties, expressed or implied, including, without limitation, the warranties of merchantability and of fitness for any purpose. The Contributing Authors and Group 42, Inc. assume no liability for direct, indirect, incidental, special, exemplary, or consequential damages, which may result from the use of the PNG Reference Library, even if advised of the possibility of such damage.

Permission is hereby granted to use, copy, modify, and distribute this source code, or portions hereof, for any purpose, without fee, subject to the following restrictions:

1. The origin of this source code must not be misrepresented.
2. Altered versions must be plainly marked as such and must not be misrepresented as being the original source.
3. This Copyright notice may not be removed or altered from any source or altered source distribution.

The Contributing Authors and Group 42, Inc. specifically permit, without fee, and encourage the use of this source code as a component to supporting the PNG file format in commercial products. If you use this source code in a product, acknowledgment is not required but would be appreciated.

A "png_get_copyright" function is available, for convenient use in "about" boxes and the like:

```
printf("%s",png_get_copyright(NULL));
```

Also, the PNG logo (in PNG format, of course) is supplied in the files "pngbar.png" and "pngbar.jpg (88x31) and "pngnow.png" (98x31).

Libpng is OSI Certified Open Source Software. OSI Certified Open Source is a certification mark of the Open Source Initiative.

Glenn Randers-Pehrson
glennrp at users.sourceforge.net
December 18, 2008

END OF TERMS AND CONDITIONS

Kern_random

The following component is licensed under kern_random license:

Kern_random Copyright Theodore Ts'o, 1994, 1995. All rights reserved.

Kern-random License

." This code is derived from software contributed to Berkeley by Chris Torek. Redistribution and use in source and binary forms, with or without modification, are permitted provided that the following conditions are met:

." 1. Redistributions of source code must retain the above copyright notice, this list of conditions and the following disclaimer.

." 2. Redistributions in binary form must reproduce the above copyright notice, this list of conditions and the following disclaimer in the documentation and/or other materials provided with the distribution.

." 3. All advertising materials mentioning features or use of this software must display the following acknowledgement:

."This product includes software developed by the University of California, Berkeley and its contributors.

." 4. Neither the name of the University nor the names of its contributors may be used to endorse or promote products derived from this software without specific prior written permission.

."

." THIS SOFTWARE IS PROVIDED BY THE REGENTS AND CONTRIBUTORS ``AS IS'' AND ANY EXPRESS OR IMPLIED WARRANTIES, INCLUDING, BUT NOT LIMITED TO, THE IMPLIED WARRANTIES OF MERCHANTABILITY AND FITNESS FOR A PARTICULAR PURPOSE ARE DISCLAIMED. IN NO EVENT SHALL THE REGENTS OR CONTRIBUTORS BE LIABLE FOR ANY DIRECT, INDIRECT, INCIDENTAL, SPECIAL, EXEMPLARY, OR CONSEQUENTIAL DAMAGES (INCLUDING, BUT NOT LIMITED TO, PROCUREMENT OF SUBSTITUTE GOODS OR SERVICES; LOSS OF USE, DATA, OR PROFITS; OR BUSINESS INTERRUPTION)

HOWEVER CAUSED AND ON ANY THEORY OF LIABILITY, WHETHER IN CONTRACT, STRICT LIABILITY, OR TORT (INCLUDING NEGLIGENCE OR OTHERWISE) ARISING IN ANY WAY OUT OF THE USE OF THIS SOFTWARE, EVEN IF ADVISED OF THE POSSIBILITY OF SUCH DAMAGE.

."

END OF TERMS AND CONDITIONS

Wchar functions

The following component is licensed under wchar functions license:

Wchar functions

Wchar functions License

." Copyright (c) 1990, 1991, 1993

."The Regents of the University of California. All rights reserved.

."

Copyright (c) <YEAR>, <OWNER>

All rights reserved.

Redistribution and use in source and binary forms, with or without modification, are permitted provided that the following conditions are met:

Redistributions of source code must retain the above copyright notice, this list of conditions and the following disclaimer.

Redistributions in binary form must reproduce the above copyright notice, this list of conditions and the following disclaimer in the documentation and/or other materials provided with the distribution.

Neither the name of the <ORGANIZATION> nor the names of its contributors may be used to endorse or promote products derived from this software without specific prior written permission.

THIS SOFTWARE IS PROVIDED BY THE COPYRIGHT HOLDERS AND CONTRIBUTORS "AS IS" AND ANY EXPRESS OR IMPLIED WARRANTIES, INCLUDING, BUT NOT LIMITED TO, THE IMPLIED WARRANTIES OF MERCHANTABILITY AND FITNESS FOR A PARTICULAR PURPOSE ARE DISCLAIMED. IN NO EVENT SHALL THE COPYRIGHT HOLDER OR CONTRIBUTORS BE LIABLE FOR ANY DIRECT, INDIRECT, INCIDENTAL, SPECIAL, EXEMPLARY, OR CONSEQUENTIAL DAMAGES (INCLUDING, BUT NOT LIMITED TO, PROCUREMENT OF SUBSTITUTE GOODS OR SERVICES; LOSS OF

USE, DATA, OR PROFITS; OR BUSINESS INTERRUPTION) HOWEVER CAUSED AND ON ANY THEORY OF LIABILITY, WHETHER IN CONTRACT, STRICT LIABILITY, OR TORT (INCLUDING NEGLIGENCE OR OTHERWISE) ARISING IN ANY WAY OUT OF THE USE OF THIS SOFTWARE, EVEN IF ADVISED OF THE POSSIBILITY OF SUCH DAMAGE

END OF TERMS AND CONDITIONS

Libjpeg

The following component is licensed under libjpeg license:

Libjpeg

Libjpeg License

This software is copyright (C) 1991-1998, Thomas G. Lane.
All Rights Reserved except as specified below.

Permission is hereby granted to use, copy, modify, and distribute this software (or portions thereof) for any purpose, without fee, subject to these conditions:

- (1) If any part of the source code for this software is distributed, then this README file must be included, with this copyright and no-warranty notice unaltered; and any additions, deletions, or changes to the original files must be clearly indicated in accompanying documentation.
- (2) If only executable code is distributed, then the accompanying documentation must state that "this software is based in part on the work of the Independent JPEG Group".
- (3) Permission for use of this software is granted only if the user accepts full responsibility for any undesirable consequences; the authors accept NO LIABILITY for damages of any kind.

These conditions apply to any software derived from or based on the IJG code, not just to the unmodified library. If you use our work, you ought to acknowledge us.

Permission is NOT granted for the use of any IJG author's name or company name in advertising or publicity relating to this software or products derived from it. This software may be referred to only as "the Independent JPEG Group's software".

We specifically permit and encourage the use of this software as the basis of commercial products, provided that all warranty or liability claims are assumed by the product vendor.

END OF TERMS AND CONDITIONS

T-Rex

The following component is licensed under the T-Rex license:

T-Rex

T-Rex License

Copyright (C) 2003-2004 Alberto Demichelis

This software is provided 'as-is', without any express or implied warranty. In no event will the authors be held liable for any damages arising from the use of this software.

Permission is granted to anyone to use this software for any purpose, including commercial applications, and to alter it and redistribute it freely, subject to the following restrictions:

1. The origin of this software must not be misrepresented; you must not claim that you wrote the original software. If you use this software in a product, an acknowledgment in the product documentation would be appreciated but is not required.
2. Altered source versions must be plainly marked as such, and must not be misrepresented as being the original software.
3. This notice may not be removed or altered from any source distribution.

END OF TERMS AND CONDITIONS

